



## TiF-100. Ti:Sapphire Femtosecond Solid-State Oscillator

- Wavelength range as broad as 715-980 nm
- Pulse duration <100 fs
- Output power up to 1.55 W (with a 10-W pump laser)
- Thermostabilized monolithic sealed body
- Motorized USB wavelength tuning
- Mode-lock starter
- Built-in spectrometer/power meter (optional)
- Tunable fs/CW switchable regimes (optional)
- Active power locking (optional)



*The TiF-100F10-ST femtosecond Ti:Sapphire laser with an integrated 10-W pump source*

### Product overview

The TiF-100 laser system offers the highest average power and the broadest tuning range in the TiF laser family. The unit is a flexible tool suitable for numerous applications and can really be a workhorse for many different projects going on simultaneously.

The system can be supplied in two basic configurations: the TiF-100, being a stand-alone version for pumping with an external pump laser; or the TiF-100F system which may be integrated with an industry-standard pump laser on site or at our factory. However, the dimensions of the Ti:S laser head are the same for either version, the stand-alone version may later be fitted with an integrated pump laser at minimum additional cost. The acceptable pump laser power for the TiF-100/TiF-100F is up to 10 Watts. See tuning curves in the datasheet for output power vs. wavelength dependence.

There are two pre-designed factory supply packages:

- a basic factory package includes a simple USB motorized wavelength tuning slit and a push-button non-automatic electric starter. Wavelength tuning and calibration with this package is done via step number information in basic Windows software.
- the "Auto" factory package includes built-in spectrometer and power meter, single-touch wavelength tuning with presets, configurable widget software, active power lock function and automatic mode-lock start and monitoring. With this package the system boasts exceptional long-term stability and longer uninterrupted runtime.

The system can also be equipped with an optional birefringent filter and optional etalons providing narrowband tunable CW regime over the whole tuning range.

An external prism pair or a tunable pulse compressor (the APC Kit or APC Pro units) for dispersion pre-compensation is also available.

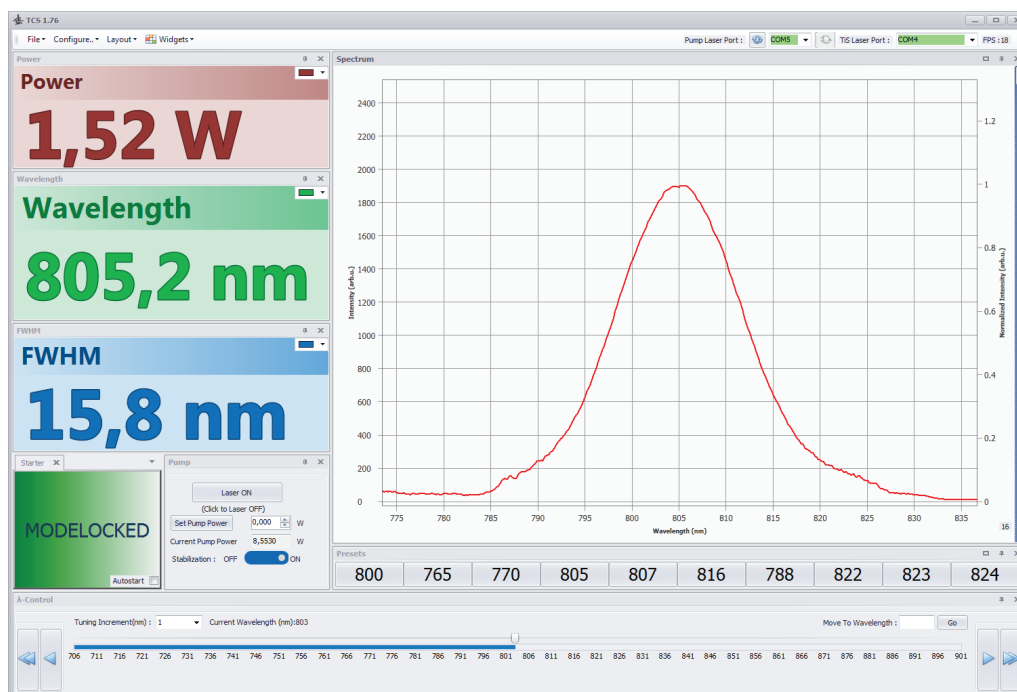

*Widget-based software screenshot for the TiF family of lasers with integrated spectrometer ("Auto" package)*

### Applications:

- Multiphoton microscopy
- Seed oscillator for amplifier systems
- Terahertz generation
- "Pump-probe" spectroscopy
- Material processing
- Optical coherent tomography



### Standard models and available pump laser power matrix

Pump laser power	TiF-100ST (standard wavelength range)		TiF-100LW (extended IR range)	
	Wavelength tuning	Output power	Wavelength tuning	Output power
3 W	740-860 nm	>350 mW at 800 nm	n/a	n/a
4 W	735-870 nm	>500 mW at 800 nm	n/a	n/a
5 W	730-875 nm	>650 mW at 800 nm	830-950 nm	>200 mW at 950 nm
6 W	725-880 nm	>850 mW at 800 nm	830-960 nm	>200 mW at 960 nm
8 W	720-885 nm	>1.25 W at 800 nm	830-970 nm	>200 mW at 970 nm
10 W	715-890 nm	>1.55 W at 800 nm	830-980 nm	>150 mW at 980 nm

*It is possible to combine both ranges in a single laser system, please enquire for details.*

### General optical specifications

Output pulse duration <sup>1)</sup>	<100 fs
Spectrum width <sup>1)</sup> (FWHM)	>8 nm
Pulse repetition rate (fixed)	80±10 MHz
Pump laser	integrated or stand-alone DPSS 500...550 nm low-noise laser (up to 10 W)
Beam mode	TEM <sub>00</sub> (M <sup>2</sup> <1.2)
Beam diameter (at 1/e <sup>2</sup> )	<2 mm
Output polarization	linear, horizontal, PER >20 dB
Beam divergence	<1 mrad
Long-term stability <sup>2)</sup>	<0.2% rms
Noise <sup>3)</sup>	<0.1% rms

### Physical dimensions (L × W × H)

Laser head	516 × 350 × 118 mm (including integrated pump laser)
Pump laser control unit	353 × 360 × 119 mm
Closed-loop chiller	430 × 340 × 190 mm

### Environmental and utility specifications

Operating temperature	15-30 °C
Relative humidity	<60%, non-condensing
Voltage	single-phase; 100-240 VAC; 50/60 Hz
Power consumption	<2 kW

### Available configuration packages<sup>4)</sup>

Thermally stabilized monolithic body	included in any package
Pulse train SMA output with mode-lock LED	included in any package
"Auto" factory package	<ul style="list-style-type: none"> <li>- built-in spectrometer</li> <li>- single-touch wavelength tuning w. presets</li> <li>- built-in power meter</li> <li>- active output power stability locking</li> <li>- Windows software with configurable widgets</li> <li>- automatic mode-lock start and monitoring</li> <li>PC requirements: USB 2.0 port, Windows 10</li> </ul>
"Basic" factory package (default)	<ul style="list-style-type: none"> <li>- push-button starter</li> <li>- USB 2.0 wavelength tuning via step-motor slit (via step number information and calibration)</li> <li>PC requirements: USB 2.0 port, Windows 10</li> </ul>
"Manual" factory package	<ul style="list-style-type: none"> <li>- push-button starter</li> <li>- manual wavelength tuning slit</li> </ul>

1) - when tuned to 800 nm central wavelength;

2) - after 30 min warm-up with cold start, during 12-hour continuous operation under equal room temperature conditions using recommended stabilized closed-loop chiller with proper capacity and recommended low-noise on-board integrated highly stable pump laser with active power locking;

3) - measured from 10 Hz to 10 MHz;

4) - please select one of the packages for your system; certain features may be tailored or combined differently according to specific customer requirements.

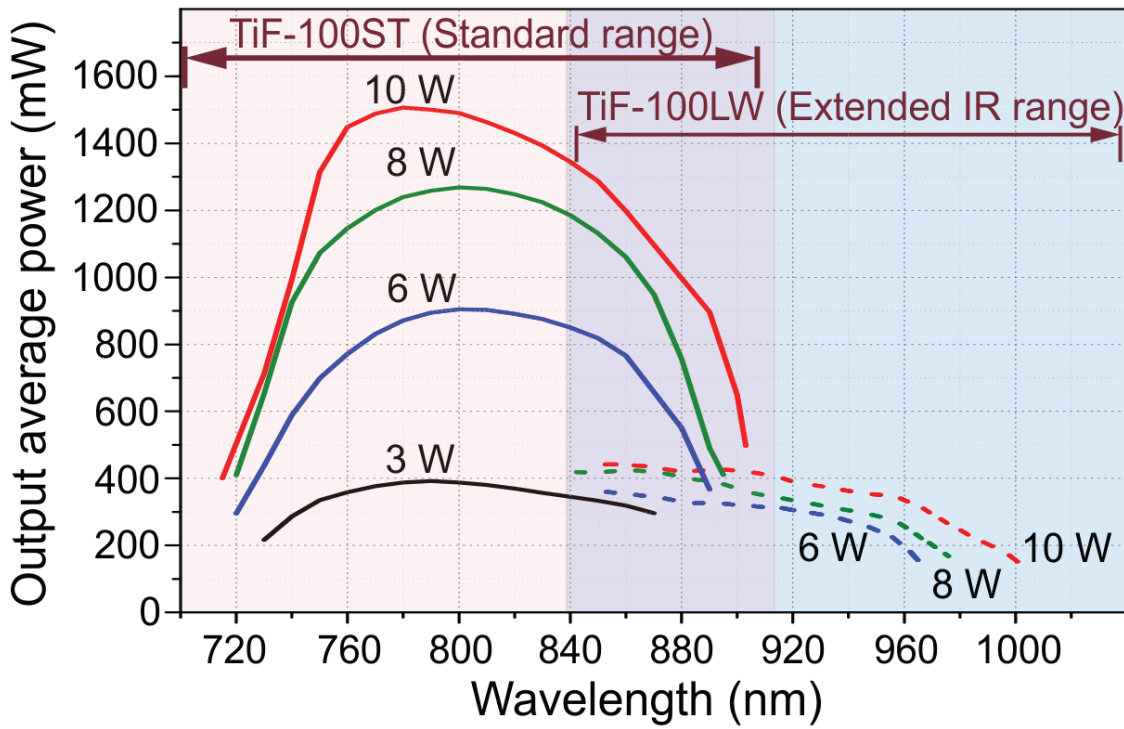

TiF-100 wavelength tuning curves at various pump laser power ratings

Typical TiF-100 Autocorrelation trace and Spectrum

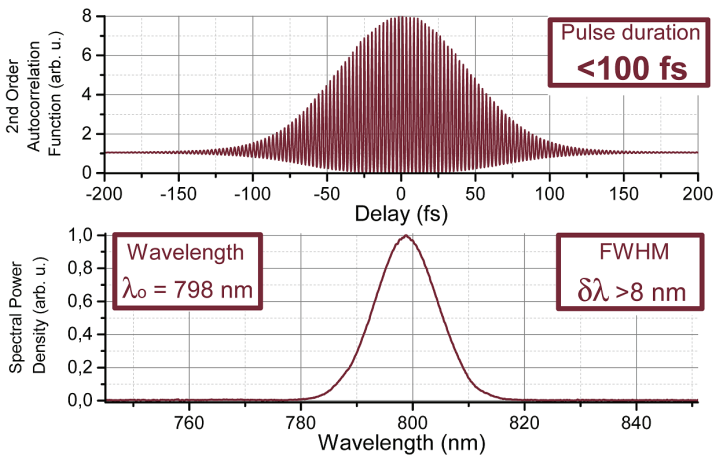

TiF-100 Typical Long Term Power Stability

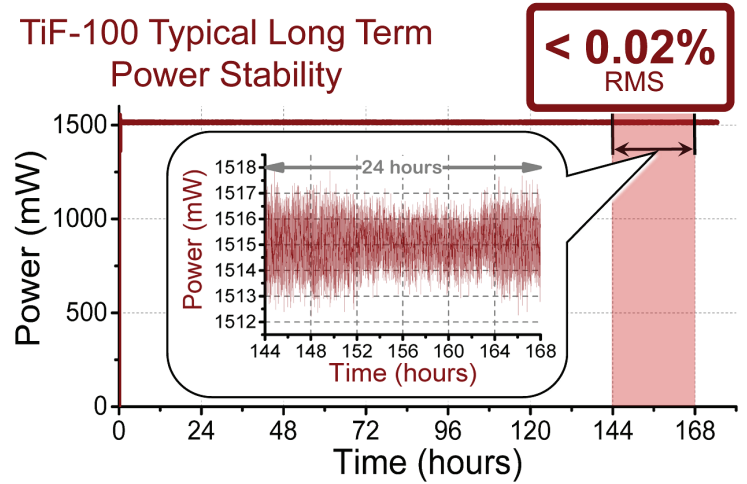

168 hours continuous stability run, acquired using an integrated Lighthouse Photonics Sprout-D-10 W, 532 nm pump laser, at an ambient temperature of 22 degrees C and coolant (distilled water) temperature of 20 degrees, with "Auto" package and active power locking

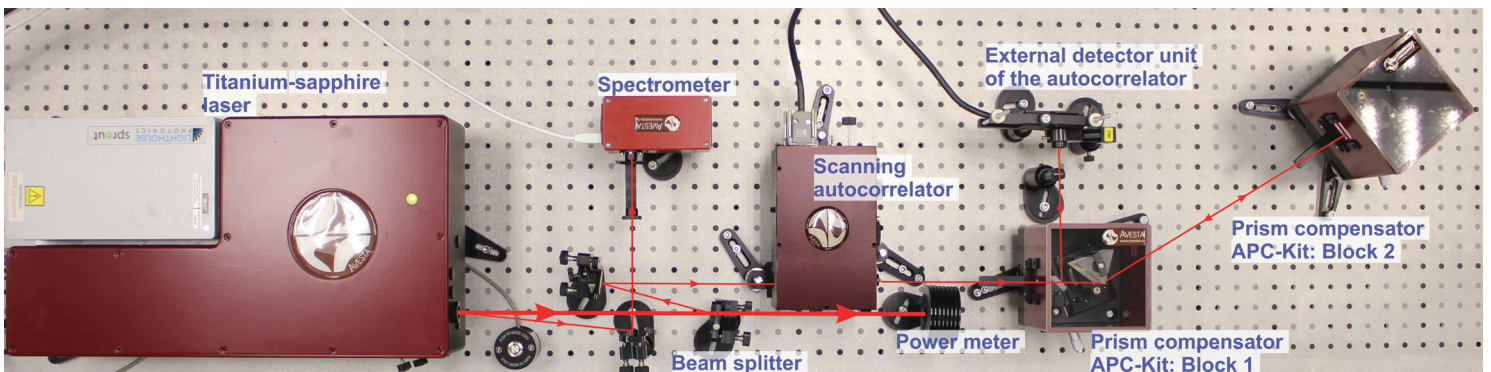

Possible total dispersion control setup for multi-photon microscopy applications with APC Kit dispersion compensator and AA-M scanning autocorrelator with an external detector unit

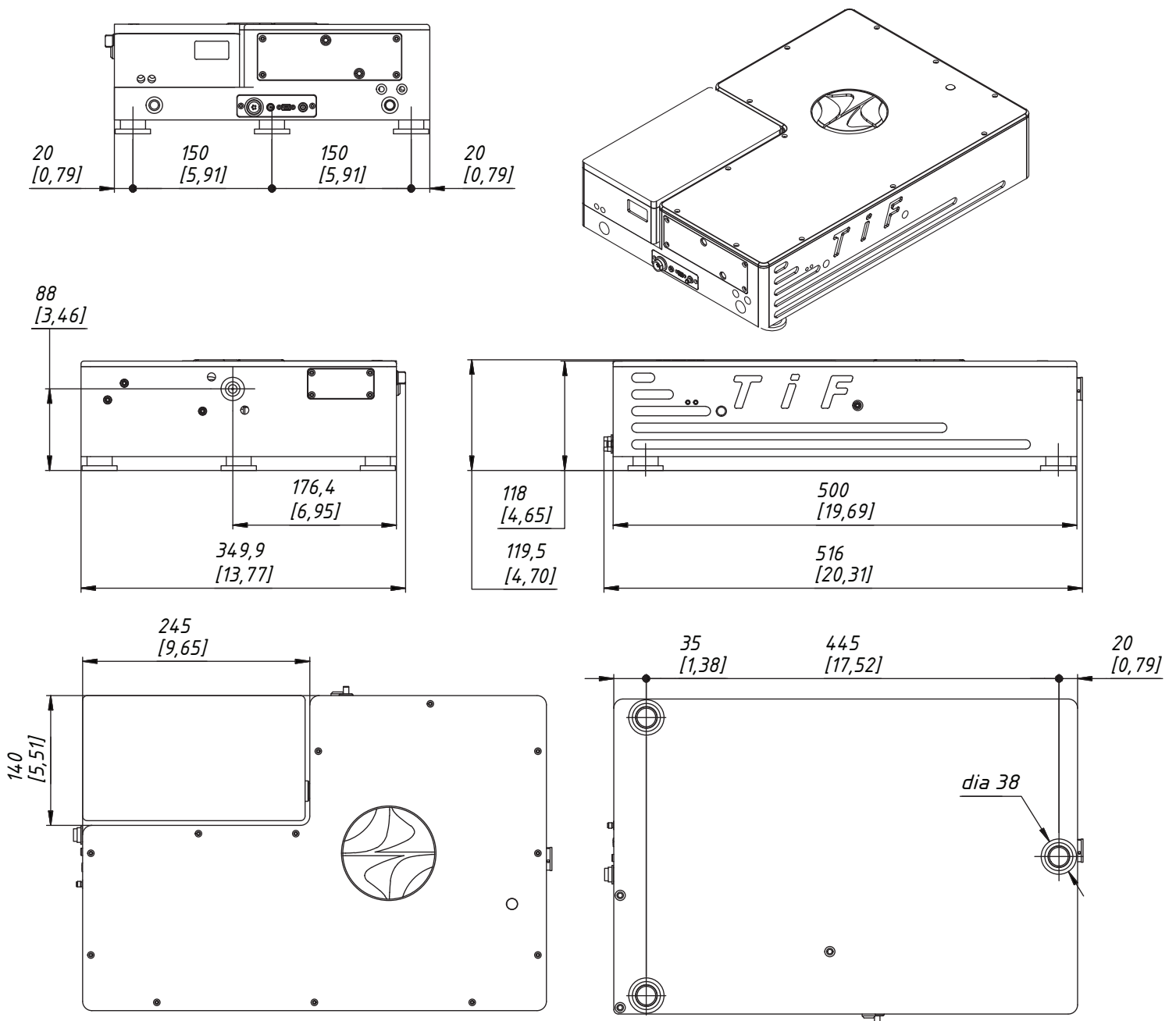

TiF-100 / TiF-100F dimensions in mm [inch] with integrated pump laser head

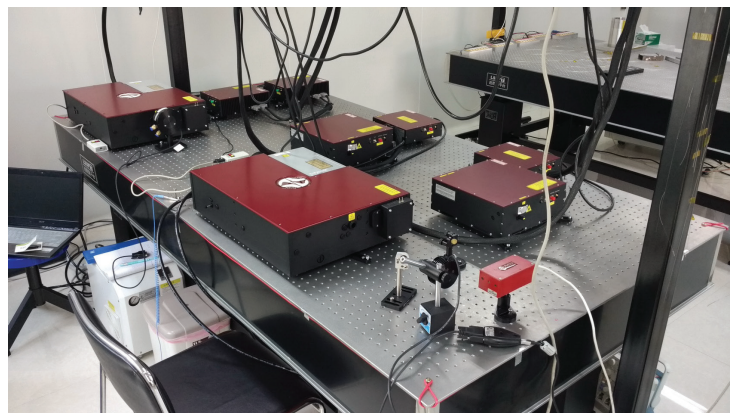

Installed TiF-100 systems at customers' sites