



PERL. Compact Femtosecond Er-Fiber Laser

- Small footprint and integrated design
- Pulse widths down to 50 fs
- Near transform-limited output with minimal pulse pedestal
- Low timing jitter and RF-sync output
- PM models
- Optional built-in SHG for 790 nm output



PERL-PM/PERL-PM-SH fiber laser system with free-space output

Product overview

The smallest but not the least, the PERL is an ultrafast fiber laser operating in C-band (1530-1565 nm). The rigid design of the laser ensures insensitivity to physical and vibration impact, high stability, repeatability of initial specs that is in high demand with OEM applications. There are two versions of the laser: the PERL-OEM being a cost-effective minimalistic version without linearly polarized output, and the PERL-PM version with linearly polarized output and ultra-short pulse capability.

For the **PERL-OEM**, the pulse duration can be ordered in the range of 250 fs...5 ps, pulse shape being close to transform-limited. The PERL laser with average power rating up to 50 mW is a nice budget-friendly solution for low-power ultrafast applications. The only thing needed for OEM operation is a power source with +5 V (the power adapter for standard 110/220 V network is supplied with the laser).

The **PERL-PM** features PM fiber architecture and PM fiber socket output with fiber pigtail lengths up to 1 m. An optional free-space collimator may also be supplied with the unit. The system offers pulse duration as low as 50 fs and is a versatile tool for semiconductor studies and for THz generation.

The **PERL-PM-SH** unit features a built-in second-harmonic generator with 790-nm output and is also available with an optional external separator unit for simultaneous fundamental/SHG outputs.

High frequency electrical output can be used as a trigger source for synchronization systems. The laser can act as a stand-alone pulse source, as well as operate in complex systems.

PERL technical specifications

	PERL-OEM	PERL-PM	PERL-PM-SH
Pulse duration (FWHM, sech² fit)	250 fs...5 ps*	<80 fs (typically 50 fs)	<100 fs (typically 80 fs)
Wavelength (fixed)	1560±10 nm	1560±10 nm	790±20** nm
Output power	>50 mW	30...150* mW (typically up to 200 mW)	
Pulse repetition rate, fixed	60±5 MHz	30...100* MHz	100±5 MHz
Pulse energy	up to 1 nJ	up to 2* nJ	
Output type	FC/APC fiber socket on laser head or up to 1* m pigtail (option: free-space collimator)		free-space
Output polarization	not specified	linear, PER >20 dB	linear, PER >20 dB
Outputs	Sync RF SMA, USB incl. PC software		
Optical head dimensions (incl. electronics)	136x76x24(27) mm	200x130x70 mm	200x130x70 mm (at 50 mW output)
Power supply voltage	OEM +5 V DC (100-220 V AC adapter included)	100-220 V AC adapter included	

* - fixed at factory inside this range, please indicate the desired value with your request; final specifications and pricing depend on the requested output power rating;

** - an optional external separator unit is available upon request for simultaneous 1560 nm and 790 nm outputs.



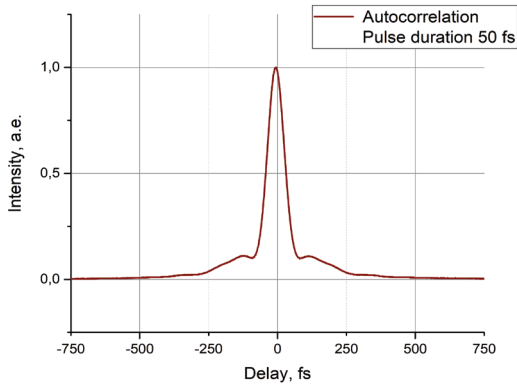

PERL-PM-HP typical AC envelope at 140 mW, 100 MHz

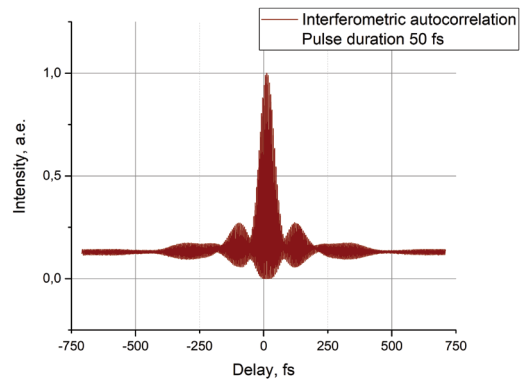

PERL-PM-HP typical AC fringe structure at 140 mW, 100 MHz

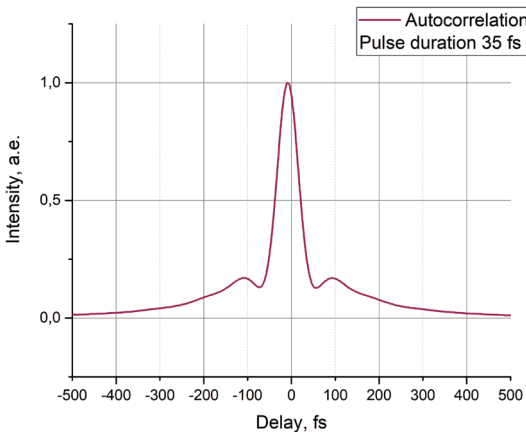

PERL-PM-EHP typical AC envelope at 210 mW, 100 MHz

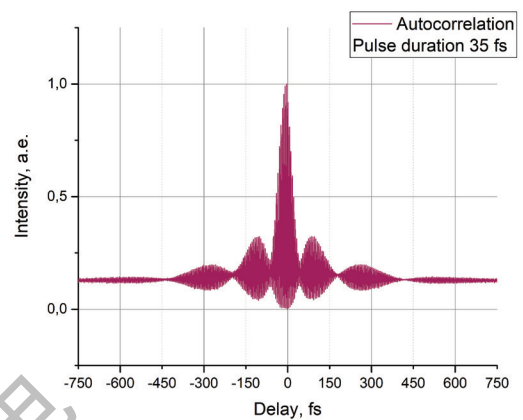

PERL-PM-EHP typical AC fringe structure at 210 mW, 100 MHz

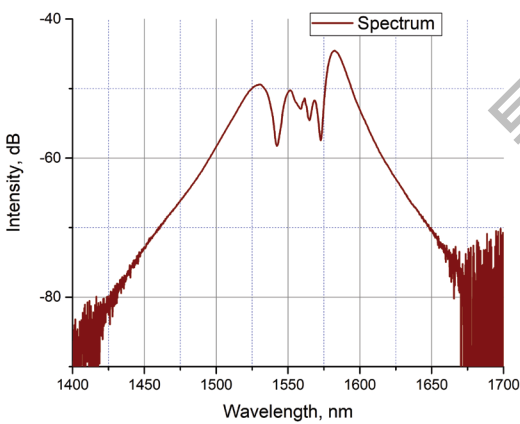

PERL-PM series typical spectrum sample (log scale)

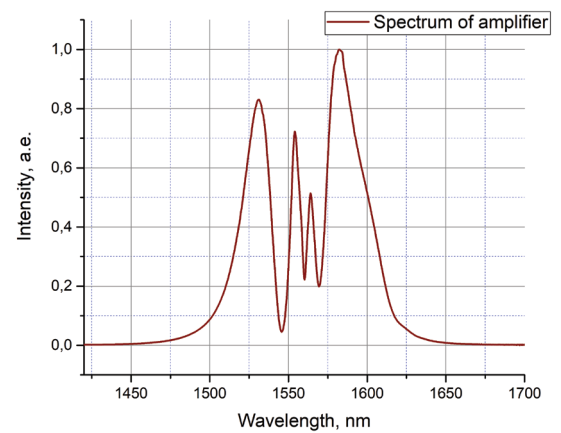

PERL-PM series typical spectrum sample (linear scale)

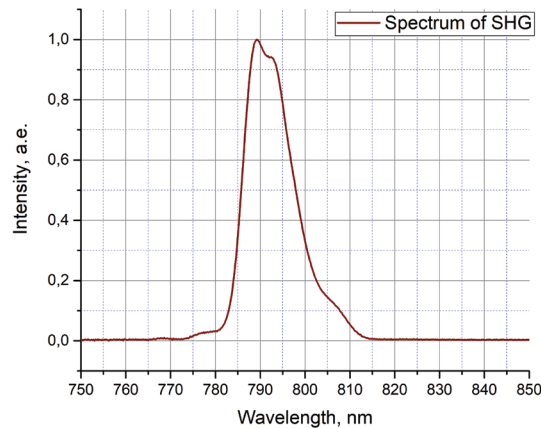

PERL-PM-SH typical spectrum sample

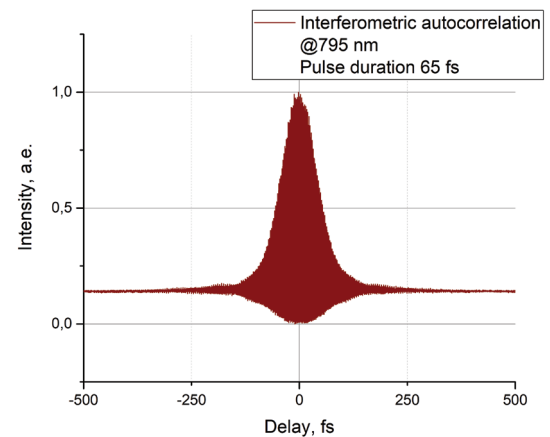

PERL-PM-SH typical AC fringe structure at 60 mW, 100 MHz

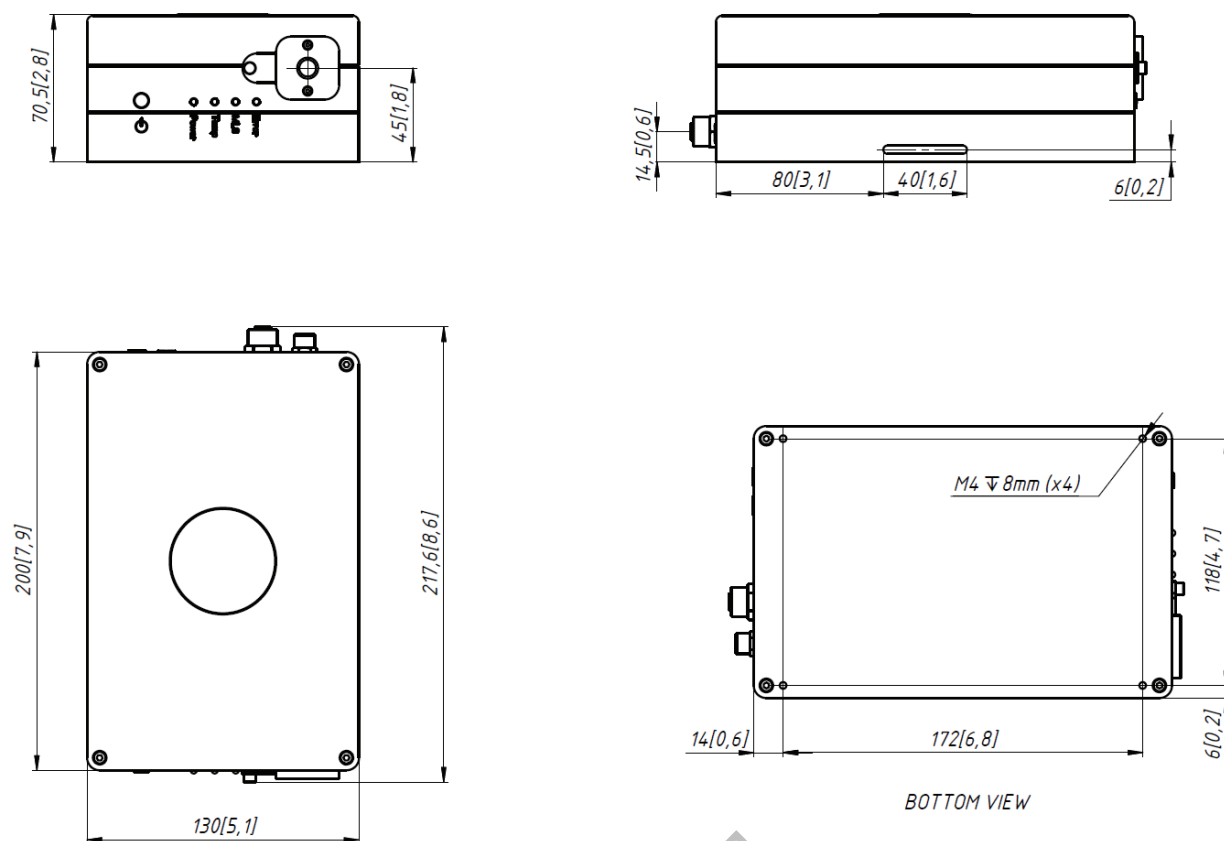

PERL-PM/PERL-PM-SH dimensions in mm [in.]



PERL-OEM Er-doped fiber laser system

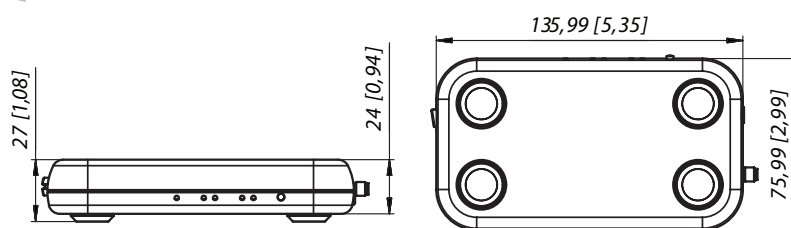

PERL-OEM dimensions in mm [in.]

Applications:

- Terahertz radiation • OEM integration • Telecommunication components characterization •
- Optical high speed sampling • Optical switching • Materials characterization • Optical metrology