

## Liquid Crystal Variable Retarders

These products all use nematic liquid crystal materials to electrically control polarization. Meadowlark Optics standard liquid crystal products provide tunable retardation by changing the effective birefringence of the material with applied voltage, thus altering the input polarized light to any chosen elliptical, linear or circular polarization.

Our precision Liquid Crystal Variable Retarders require unique fabrication and assembly steps. We construct these retarders using optically flat fused silica windows coated with our transparent conductive Indium Tin Oxide (ITO). Our ITO coating is specially designed for maximum transmission from 450 – 1800 nm

A thin dielectric layer is applied over the ITO and gently rubbed, to provide for liquid crystal molecular alignment. Two windows are then carefully aligned and spaced a few microns apart. The cavity is filled with birefringent nematic liquid crystal material. Electrical contacts are attached and the device is environmentally sealed. We carefully place the Liquid Crystal Variable Retarder in an anodized aluminum housing such that the fast and slow axes are both at 45° relative to a convenient mounting hole.

Typical Transmission Through an Uncoated Liquid Crystal Device

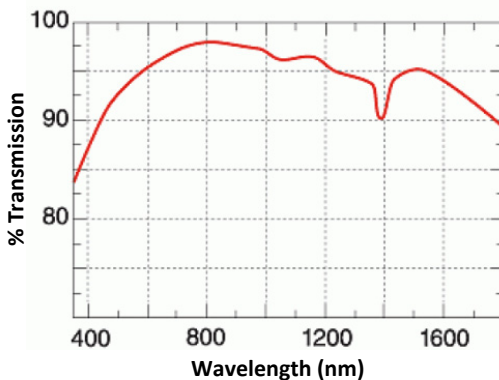

Anisotropic nematic liquid crystal molecules from uniaxial birefringent layers in the liquid crystal cell. An essential feature of nematic material is that, on average, molecules are aligned with their long axes parallel, but with their centers randomly distributed. With no voltage applied, the liquid crystal molecules lie parallel to the glass substrates and maximum retardation is achieved.



### Key Features

• • •

- Computer control capability
- Temperature control options
- Usable from 450 to 1800 nm
- Precision non-mechanical retardation control

### Liquid Crystal Suite

• • •

#### Variable Retarders

- Liquid Crystal Variable Retarder
- UV Variable Retarder
- MWIR Variable Retarder
- OEM LCVR

#### Rotators

- Achromatic High Speed Rotator
- Binary Rotator
- Polarization Rotator

#### Shutters / Attenuators

- Achromatic High Speed Shutter
- High Contrast Shutter
- Variable Attenuator

#### Controllers

- Analog Controller
- FLC Controller
- LC Digital Interface Controller
- Temperature Controller
- Two Channel High Voltage Controller



When voltage is applied, liquid crystal molecules begin to tip perpendicular to the fused silica windows. As voltage increases, molecules tip further causing a reduction in the effective birefringence and hence, retardance. Molecules at the surface, however, are unable to rotate freely because they are pinned at the alignment layer. This surface pinning causes a residual retardance of ~30 nm even at high voltage (20 volts).

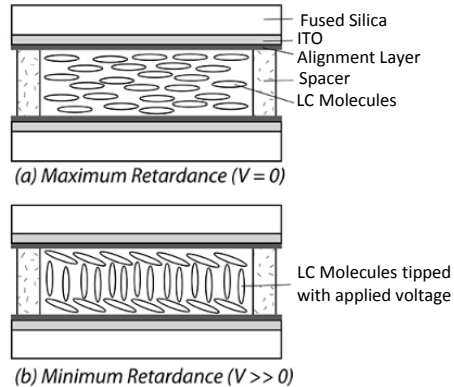

**Liquid Crystal Variable Retarder construction showing molecular alignment  
(a) without and (b) with applied voltage**

We achieve zero (or any custom) retardance with a subtractive fixed polymer retarder, called a compensator, attached to the liquid crystal cell. Negative retardance values are sometimes preferred, for example, when converting between right- and left-circularly polarized states. Placing a compensated Liquid Crystal Variable Retarder between two high extinction polarizers creates an excellent optical attenuator, with convenient electronic control.

As with any anisotropic material, retardance is dependent upon thickness and birefringence. Liquid crystal material birefringence depends on operating wavelength, drive voltage and temperature. The overall retardance of a liquid crystal cell decreases with increasing temperature (approximately -0.4% per °C).

### Response Time

Liquid Crystal Variable Retarder response time depends on several parameters, including layer thickness, viscosity, temperature, variations in drive voltage and surface treatment. Liquid crystal response time is proportional to the square of the layer thickness and therefore, the square of the total retardance.

Response time also depends upon direction of the retardance change. If the retardance increases, response time is determined solely by mechanical relaxation of the molecules. If retardance decreases in value, response time is much faster due to the increased electric field across the liquid crystal layer. It takes about 5 ms to switch from one-half to zero waves (low to high voltage) and about 20 ms to switch from zero to one-half wave (high to low voltage).

Response time improves by using custom materials with high birefringence and a thinner liquid crystal layer. At higher temperature, material viscosity decreases, also contributing to a faster response.

Another technique involves the Transient Nematic Effect (TNE) to improve response times. With this drive method, a high voltage spike is applied to accelerate the molecular alignment parallel to the applied field. Voltage is then reduced to achieve the desired retardance.



When switching from low to high retardance all voltage is momentarily removed to allow the liquid crystal molecules to undergo natural relaxation. Our Four Channel Digital Interface conveniently provides the necessary TNE voltage profiles.

Our standard Liquid Crystal Variable Retarders provide a minimum retardance range of  $\sim 30$  nm to at least half-wave at the specified wavelength. With an attached compensator, retardance is guaranteed to range from zero to at least half-wave at the specified wavelength. Custom retardance ranges (up to a few waves) and custom compensators are available. Contact our sales department to discuss your requirements.

Each Liquid Crystal Variable Retarder is supplied with retardance versus voltage performance data for your specified wavelength. A coaxial cable with mating connector is provided for easy attachment to one of our electronic controllers.

Temporal response of LC Variable Retarder with an applied voltage at 2 kHz square wave. Excessive DC voltage will damage the liquid crystal

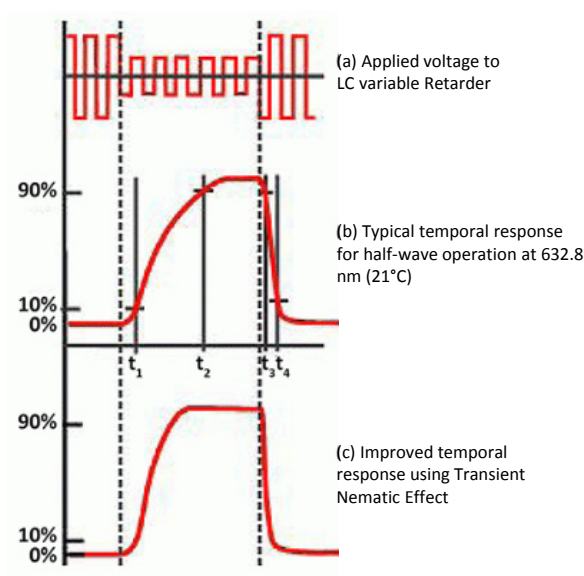

Liquid Crystal Variable Retarder performance versus applied voltage at 632.8 nm, 210 C.

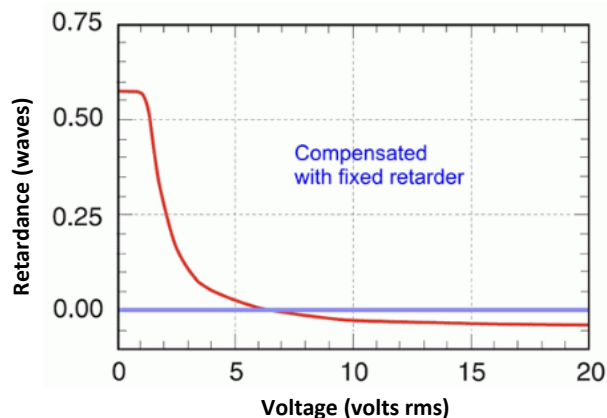
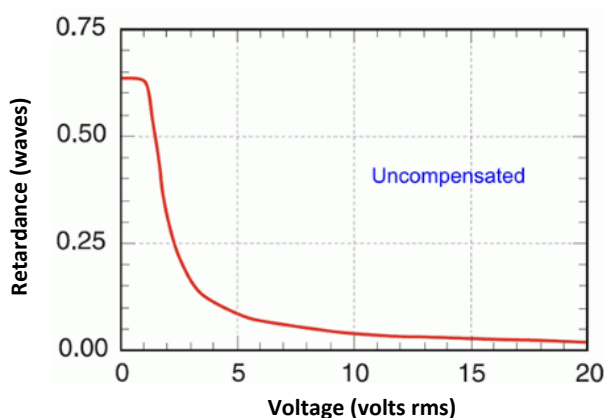



Liquid crystal devices should be electrically driven with an AC waveform with no DC component to prevent ionic buildup which can damage the liquid crystal layer. We require a 2 kHz square wave of adjustable amplitude for controlling our Liquid Crystal Variable Retarders (LCVR). Our Basic Controller and Four Channel Interface ensure these drive requirements are met. A temperature sensing and control option can be added to our LCVRs for accurate controlling of the operating temperature. The sensor is attached directly to the LCVR substrate, outside its clear aperture. Without this option, retardance decreases by approximately 0.2% to 0.3% per °C increase in temperature.

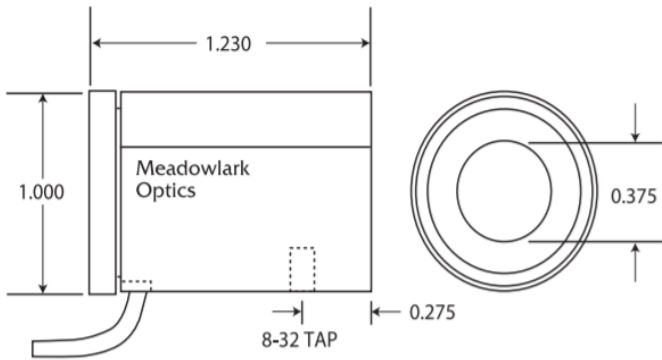

Model LVR-100 Dimensions

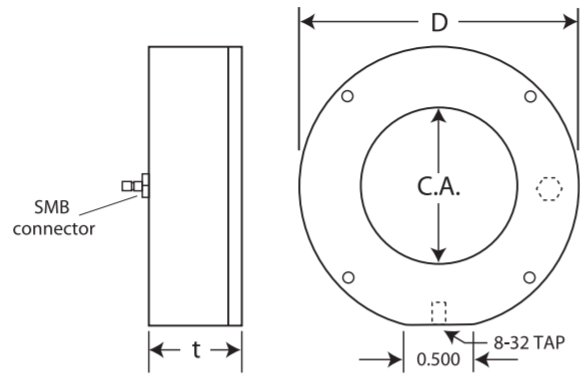

Model LVR-200 and LVR-300 Dimensions

| SPECIFICATIONS                                 |   |
|--|---|
| Retarder Material                              | Nematic liquid crystal  |
| Substrate Material                             | Optical quality synthetic fused silica                                |
| Wavelength Range                               | 450 – 1800 nm (specify)   |
| <b>Retardance Range</b>                        |   |
| Without Compensator                            | ~30 nm to $\lambda/2$   |
| With Compensator                               | 0 to $\lambda/2$<br>(Custom ranges are available)                     |
| Transmitted Wavefront Distortion (at 632.8 nm) | $\leq \lambda/4$  |
| Surface Quality                                | 40 – 20 scratch-dig   |
| Beam Deviation                                 | $\leq 2$ arc min  |
| Reflectance (per surface)                      | $\leq 0.5\%$ at normal incidence                                      |
| Diameter Tolerance                             | $\pm 0.005$ in.   |
| Temperature Range                              | 0°C to 50°C   |
| Recommended Safe Operating Limit               | 500 W/cm <sup>2</sup> , CW<br>300 mJ/cm <sup>2</sup> , 10 ns, visible |

| ORDERING INFORMATION  |                          |                    |             |
|---|--------------------------|--------------------|-------------|
| Diameter, D (in.)   | Clear Aperture, CA (in.) | Thickness, t (in.) | Part Number |
| <b>Without Attached Compensator (30 nm to <math>\lambda/2</math>)</b> |                          |                    |             |
| 1.00  | 0.37                     | 1.23               | LVR – 100   |
| 2.00  | 0.70                     | 0.75               | LVR – 200   |
| 3.00  | 1.60                     | 1.00               | LVR – 300   |
| <b>With Attached Compensator (0 nm to <math>\lambda/2</math>)</b>     |                          |                    |             |
| 1.00  | 0.37                     | 1.23               | LRC – 100   |
| 2.00  | 0.70                     | 0.75               | LRC – 200   |
| 3.00  | 1.60                     | 1.00               | LRC – 300   |

[Spark-920nm 飞秒激光器](#)



[Spark-920/1064nm 激光器 \(功率可调、可光纤输出\)](#)



[Calmar-780nm 激光器](#)



[Calmar-1550nm 激光器](#)



[Avesta-715-980nm 钛宝石激光器](#)



[Cycle-1300/1700nm 双波长激光器](#)



[Oxxius - 多波长合束激光器](#)

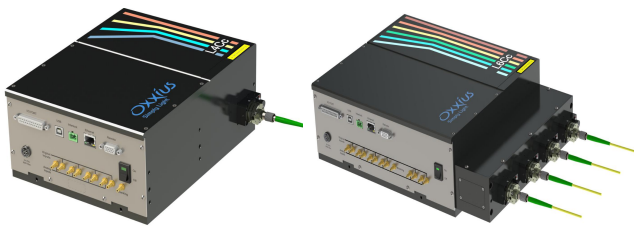

[Meadowlark-纯相位液晶空间光调制器 \(SLM\)](#)



[Meadowlark-液晶相位延迟器、螺（涡）旋相位板](#)   [Forth DD-纯振幅液晶空间光调制器 \(LCOS\)](#)

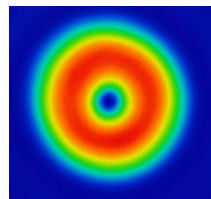

[ViALUX-DMD 数字显微镜](#)

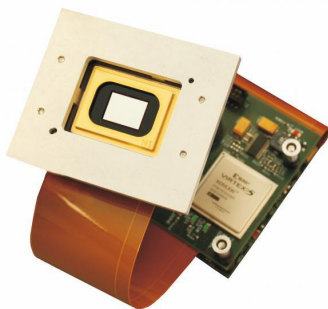

[Conoptics-电光调制器 \(EOM\)](#)



[Gooch&Housego-声光调制器](#)



详情请点击图片链接下载数据单

[www.auniontech.com](http://www.auniontech.com)



[Ximea -高性价比sCOMS相机](#)



[Lambert -高速荧光相机](#)



[Photonscore -TCSPC单光子相机](#)



[Photon etc -深度制冷短波红外相机](#)



[Chroma-荧光滤光片](#)

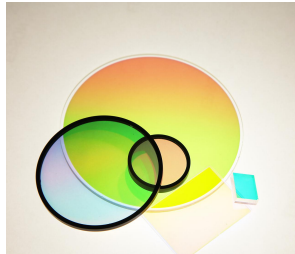

[PHOTONICS BRETAGNE - Kagome光子晶体光纤](#)

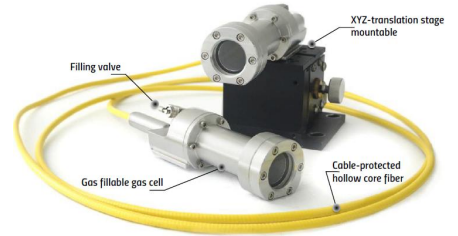

[PIEZOCONCEPT-压电平移台](#)



[PIEZOCONCEPT-物镜扫描台](#)



[ASI-显微镜载物台](#)

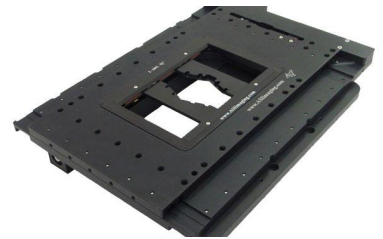

[Mirrorcle-MEMS扫描镜](#)

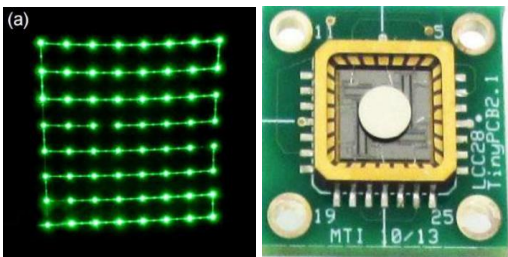

[TAG -超快声光可变焦透镜](#)



[Minus K -桌面型隔振平台](#)



[Avesta-棱镜色散补偿器](#)



[Swamp Optics-BOA脉冲压缩器](#)

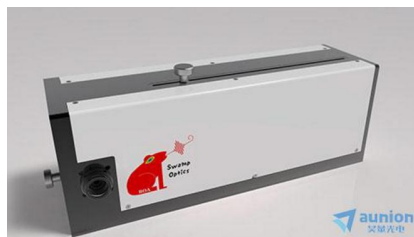

[Avesta-双子吸收自相关仪](#)



详情请点击图片链接下载数据单

[www.auniontech.com](http://www.auniontech.com)