

Impedance Analyzer

6632

Features

- Signal source frequency range: DC, 10Hz to 1/3/5/10/20/30MHz
- Basic accuracy up to $\pm 0.08\%$ (typical $\pm 0.05\%$)
- ALC function
- Output impedance $25\Omega/100\Omega$, switchable
- Support meter mode and list mode, sweep mode, and equivalent circuit analysis (option) function
- Built-in DC Bias voltage $\pm 12V$, optional plug-in DC Bias voltage/current 0 to $\pm 40V/\pm 100mA$
- Measurement of piezoelectric element admittance circle, and can measure DC bias characteristic of capacitance value.
- Ultra-high measuring speed $< 3ms$
- Open circuit/short circuit/load correction function
- Up to four parameters can be selected in the electric meter mode. The inductance and DCR values can be measured and displayed simultaneously
- Auto component classification: Comparator function and Handler BIN classification function
- Can be used with various fixtures, such as: liquid dielectric material test fixture, dielectric material test fixture and magnetic material test fixture.....etc.
- Using with DC bias current test system 6210/6220/6240
- Support RS-232, GPIB, Handler, LAN, USB Host/Device interfaces
- Using in R & D department, process development and laboratory
- PC connection data analysis software is available

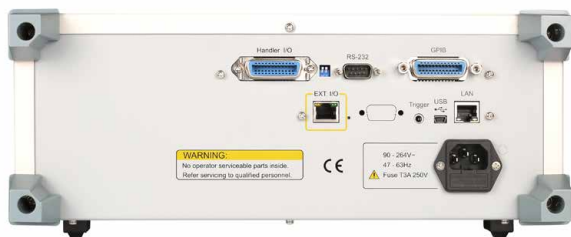

CE RS-232 Handler USB Host/Device GPIB LAN

Applications

Passive Components: Capacitor, Inductor, Resistor, Transformer, Ceramic resonator, Quartz Crystal

Semiconductor Components: The CV characteristics analysis of varactor diodes, Diodes

Dielectric Material: Estimation on permittivity and consumption tangent of plastic, ceramic and PCB

Other Components: Estimation of the impedance of PCB components

Accessories / Fixtures

Standard Accessories

- Power Cord
- User Manual (CD)



- FX-000C19

Optional Accessories

- PC Link software



- F423906A
Kelvin Clip Leads
(with BNC Box)



- F423503
DIP Test Fixture



- F423504
DIP Test Fixture



- FX-0000C6
Test Fixture



- F423905
SMD Test Fixture



- FX-000C10
Bottom Electrode
SMD Test Fixture



- FX-000C11
SMD Tweezer Test
Leads



- FX-000C12
SMD Test Fixture

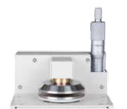

- FX-0000C7
Dielectric Material
Test Fixture



- FX-0000C8
Magnetic Material
Test Fixture



- FX-0000C9
Material Testing
Fixture



- FX-000C20
Liquid Dielectric
Material Test Fixture



- F420001
External Voltage
Bias ($\pm 200V/1MHz$)



- F420003
External Voltage
Bias ($\pm 40V/1MHz$)

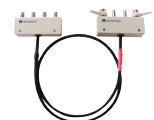

- F663001 A/B/C
BNC Test Leads

Specifications | S model is an optional equivalent circuit analysis function

Model Name	6632-1/1S	6632-3/3S	6632-5/5S	6632-10/10S	6632-20/20S	6632-30/30S
Test Frequency	10Hz-1MHz	10Hz-3MHz	10Hz-5MHz	10Hz-10MHz	10Hz-20MHz	10Hz-30MHz
Frequency Resolution	Continuity					
Frequency Output Accuracy	100mHz, 6-bit Frequency Input					
Basic Accuracy	7ppm \pm 0.01%					
AC Drive Level	\pm 0.08% (typical \pm 0.05%)					
	Test Signal Voltage Level	10mV-2Vrms				
	Voltage Minimum Resolution	1mV				
	Accuracy	ALC OFF: 10% * Voltage \pm 2mV ALC ON: 6% * Voltage \pm 2mV				
	Test Signal Current Level	200 μ A-20mA _{rms}				
	Current Minimum Resolution	10 μ A				
	Accuracy	ALC OFF: 10% * Current \pm 20 μ A ALC ON: 6% * Current \pm 20 μ A				
DC Drive Level	1V (fixed)					
Output Impedance	25 Ω , 100 Ω (switchable)					
Test Time (Fastest)	<3mS					
Measurement Parameters and Ranges	IZI	0.000m Ω -9999.99M Ω				
	R, X	\pm 0.000m Ω -9999.99M Ω				
	IYI	0.00000 μ S-999.999kS				
	G, B	\pm 0.00000 μ S-999.999kS				
	θ RAD	\pm 0.00000-3.14159				
	θ DEG	\pm 0.000 $^\circ$ -180.000 $^\circ$				
	Cs, Cp	\pm 0.00000pF-9999.99F				
	Ls, Lp	\pm 0.00nH-9999.99kH				
	D	0.00000-9999.99				
	Q	0.00-9999.99				
	Δ	\pm 0.00%-9999.99%				
	Rdc	0.00m Ω -99.9999M Ω				
	ϵ r' ϵ r''	0-100000				
	μ r' μ r''	0-100000				
Bias	DC Bias 6210/6220/6240					

General

Measurement Mode	Meter mode, list mode, sweep mode, and optional equivalent circuit analysis function (S model)	
Measurement Circuit	Series/Parallel	
Correction	Open Circuit/ Short Circuit/Load correction	
List Mode	50 groups of Multi-steps setting (Each group contains up to 15 steps)	
Built-in DC Bias	-12 to +12V, 0.3% \pm 1.5mV, 100Hz to 30MHz	
BIN	9	
Comparator	ABS, Δ ABS, Δ %, OFF	
Built-in Storage	100 sets LCR setting documents, 50 groups of list mode setting	
USB Host Storage	LCR setting documents, list mode setting document, BMP graphics, Sweep screen and test result data	
Trigger Test	Auto, manual, RS-232, GPIB, Handler	
Interface	RS-232, GPIB, Handler, LAN, USB Host/Device	
Option	PC link software	
	Equivalent Circuit Analysis	Three elements (4 models), four elements (3 models)
	Plug-in DC Bias voltage/current	0 to \pm 40V/ \pm 100mA
Power Supply	Voltage 90-264Vac	
	Frequency 47-63Hz	
	Low power consumption: Maximum 30W (Nominal value)	
Display	7.0" TFT, 800 \times 480 color screen	
Environment	Temperature: 10-40 $^\circ$ C, Humidity: 20-90%RH	
Dimension (W*H*D)	336 \times 147 \times 340mm	
Weight	3.95kg	

6632 Key Features

A Function Introduction

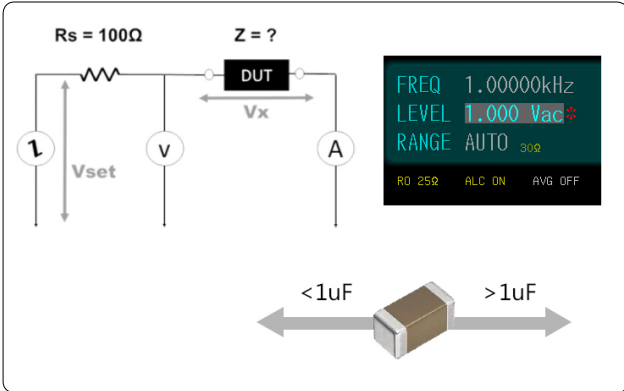

Output Impedance 25Ω/100Ω and Auto Level Control (ALC)

The key parameters for capacitance are Cs/Cp/D/Q/ESR/DC Bias Voltage.



Evaluation of DC bias voltage characteristics with semiconductor wafer or ceramic multilayer capacitors

Multi-layer ceramic capacitors (MLCC) DC Bias measuring value from 9.7uF decrease to 1.46uF.



Liquid Dielectric Material Test Fixture (C20) / Dielectric Material Test Fixture (C7)

Using C20 for measuring the characteristics of electrochemical materials and using C7 for measuring PCB board or ceramic board.

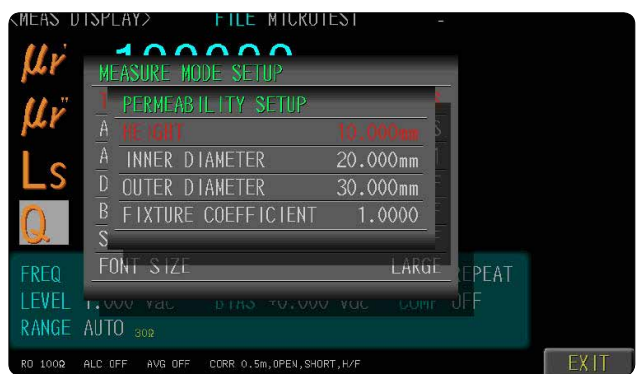

Magnetic Material Test Fixture (FX-000C8)

Using the magnetic material test fixture for measuring of permeability of various toroidal cores or ferrite cores and electromagnetic shielding coating materials, 6630 built-in formula to directly calculate the permeability coefficient value μ_r' , μ_r'' .

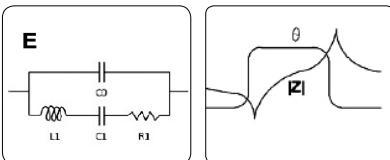
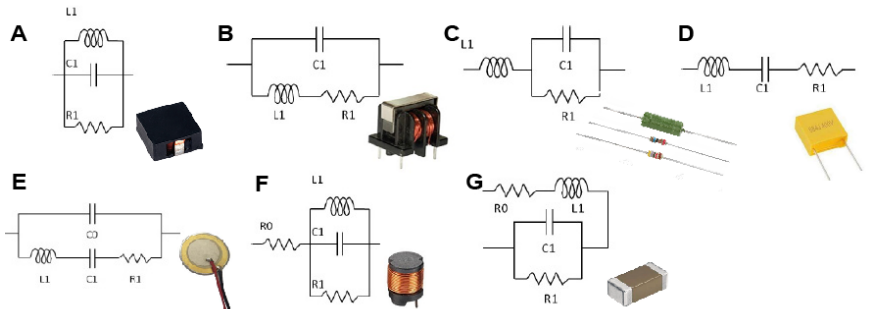
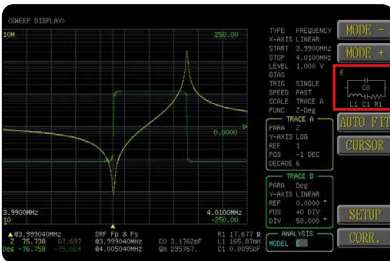

Equivalent Circuit Analysis

It has seven different models, combine with different types of parameters (R, L, C), you can see three or four elements value, and self-resonant frequency (SRF). You can simulate the impedance trace of your own equivalent circuit parameter values and then compare it with an actual measurement trace.

C Components

Passive Component



inductance
Ls / Lp / Q / SRF / I sat / I rms



MLCC / capacitance
Cs / Cp / D / Q / ESR / DC Bias Voltage

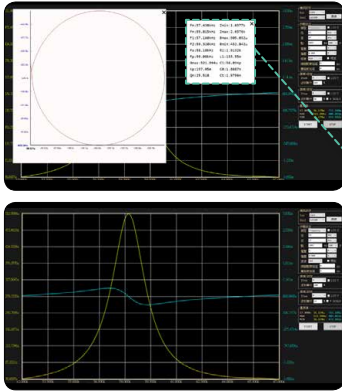

Fm: 57.430kHz Zmin: 1.0377k
 Fn: 59.815kHz Zmax: 2.0376k
 F1: 57.160kHz Bmax: 905.052u
 F2: 59.320kHz Bmin: 432.842u
 Fs: 58.18kHz R1: 1.9132k
 Fp: 59.08kHz L1: 133.55m
 Gmax: 521.994u C1: 56.034p
 Kp: 197.05m C0: 1.8687n
 Qm: 25.518 Ct: 1.9796n

Piezoelectric element/quartz crystal analysis frequency characteristics

The key parameters for Piezoelectric element /quartz crystal are Fs/Fp/Qm/Kp (Electromechanical coupling coefficient)



Evaluation impedance characteristics of RFID/NFC/automotive wireless of antennas

Using 6632 impedance analyzer equivalent circuit Analysis function.



Testing PC board inductance coil

The key parameters for 6632 impedance analyzer measuring PC board inductance coil are L/Q/DCR/Rs/SRF.

Acoustic Components



Voice coil motor / Hearing aids
Ls / Q / Qm / SRF

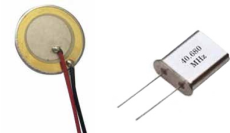

Piezoelectric element / quartz crystal
Cs / Cp / D / Fs / Fp

Material



Magnetic material
 $\mu_r'' \mu_r'$

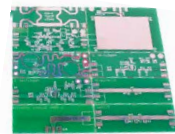

Dielectric / ceramics / Electrochemical materials
 $\epsilon_r' \epsilon_r''$

Wireless RF / Power Supply



Wireless charging
Ls / Q / SRF / DCR / Rs



NFC/low Freq. RFID
Ls / Q / SRF / DCR / Rs



battery
ESR / Cs / Cp / D

Semiconductor Components

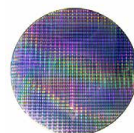

Wafer
C-V



LED Light board
Z / Cs / Cp / D



diode
Cs / Cp / D