

FEATURES

- Specific design for pulse signals
- Accommodate a variety of pulse formats
- High pulse fidelity

APPLICATIONS

- Pulse generation
- Pulse picking
- Spectroscopy
- Lidar

OPTIONS

- Heat-sink

The DR-PL-20-MO RF drivers are amplifiers module designed to drive LiNbO₃ optical modulators so as to generate undistorted optical pulses.

Electrical pulsed signals differ from classical telecom signals by long periods with no signal, when telecom signals are usually well balanced in 1 and 0. They also differ from analog signal by a wider frequency content. In order to generate clean optical pulses with sharp edges, sustained high and low levels and no overshoot, pulsed signals do require specific amplification.

The DR-PL-20-MO driver is optimized for low and high Pulse Repetition Frequency (PRF) signals from 10 Hz to 1 GHz. The bandwidth up to 20 GHz accommodates 50 ps narrow pulse width with short rise and fall time (down to 30 ps) and can withstand longer pulses up to 10 ns.

The DR-PL-20-MO drivers come in compact connectorized modules that match directly with iXblue modulators, they use a single voltage power supply for ease and safety of use and feature an output voltage control for maximum flexibility. An optional heat-sink is proposed as an accessory.

Performance Highlights

Parameter	Min	Typ	Max	Unit
Cut-off frequencies	45 k	-	18 G	Hz
Output pulse amplitude	-	-	5.2	V _{PP}
Gain	28	30	-	dB
Pulse repetition frequency	10	-	1 G	Hz
Pulse width	60 p	-	10 n	s
Rise / Fall time	-	20	35	ps

Electrical Pulse Diagram

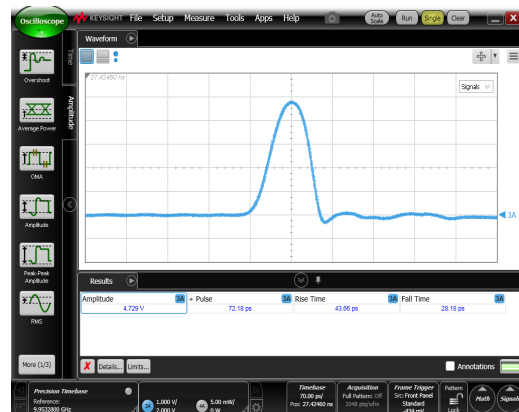

DC Electrical Characteristics

Parameter	Symbol	Min	Typ	Max	Unit
Supply voltage (fixed)	V_{bias}	-	12	-	V
Supply current	I_{bias}	-	320	400	mA
Output amplitude control voltage	V_{amp}	0	-	1.2	V
Output pulse adjustment voltage	V_{xp}	0	0.8	1.1	V

Electrical Characteristics

Parameter	Symbol	Condition	Min	Typ	Max	Unit
Lower frequency	f_{3dB} lower	-3 dB point	45	50	-	kHz
Upper frequency	f_{3dB} upper	-3 dB point	18	20	-	GHz
Gain	S_{21}	Small signal, $P_{in} = -30$ dBm	28	30	-	dB
Gain ripple	-	< 17 GHz	-	± 1.5	-	dB
Input return loss	S_{11}	50 kHz < f < 12 GHz	-	-	-10	dB
Output return loss	S_{22}	50 kHz < f < 20 GHz	-	-	-10	dB
Output pulse amplitude	V_{out}	$V_{in} = 250$ mV _{pp} , by V_{amp} adjustment	1.5	4.5	5.2	V _{pp}
Sat output pulse amplitude	V_{out}	$V_{in} = 500$ mV _{pp}	-	-	5.4	V _{pp}
Pulse repetition frequency	PRF	Duty-cycle < 0.1 %	10	-	1 G	Hz
Pulse width	PW	10 Hz < PRF < 1 GHz	60 p	-	10 n	s
Rise / Fall time	t_R / t_F	20 % - 80 %	-	20	35	ps
Power dissipation	P	-	-	3.8	5.2	W

Conditions: S parameters -30 dBm, $T_{amb} = 25^\circ\text{C}$, 50 Ω system

Absolute Maximum Ratings

Stresses in excess of the absolute maximum ratings can cause permanent damage to the device. These are absolute stress ratings only. Functional operation of the device is not implied at these or any other conditions in excess of those given in the operational sections of the data sheet. Exposure to absolute maximum ratings for extended periods can adversely affect device reliability.

Parameter	Symbol	Min	Max	Unit
RF input voltage	V_{in}	-	0.5	V _{pp}
Supply Voltage	V_{bias}	-	13	V
DC current	I_{bias}	-	0.400	A
Pulse amplitude control	V_{amp}	0	1.2	V
Pulse adjustment control	V_{xp}	0	1.1	V
Power dissipation	P_{diss}	-	5.2	W
Temperature of operation	T_{op}	-5	+40	$^\circ\text{C}$
Storage temperature	T_{st}	-20	+70	$^\circ\text{C}$

S_{21} and Group Delay Parameter Curves

Conditions: $V_{bias} = 12\text{ V}$, $V_{amp} = 1.2\text{ V}$, $V_{xp} = 0.8\text{ V}$, $I_{bias} = 300\text{ mA}$

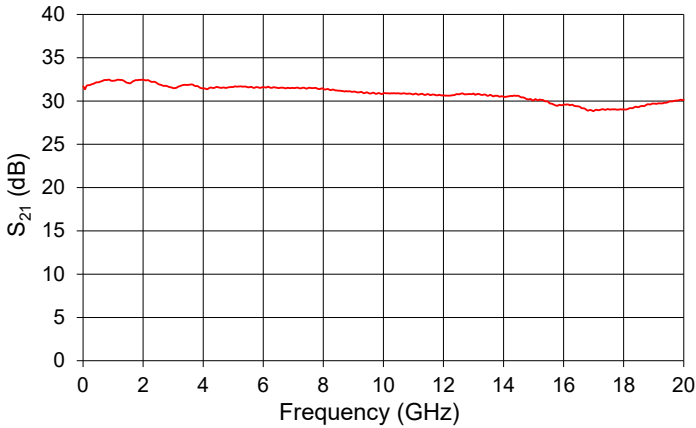

Group Delay Parameter Curve

Conditions: $V_{bias} = 12\text{ V}$, $V_{amp} = 1.2\text{ V}$, $V_{xp} = 0.8\text{ V}$, $I_{bias} = 300\text{ mA}$

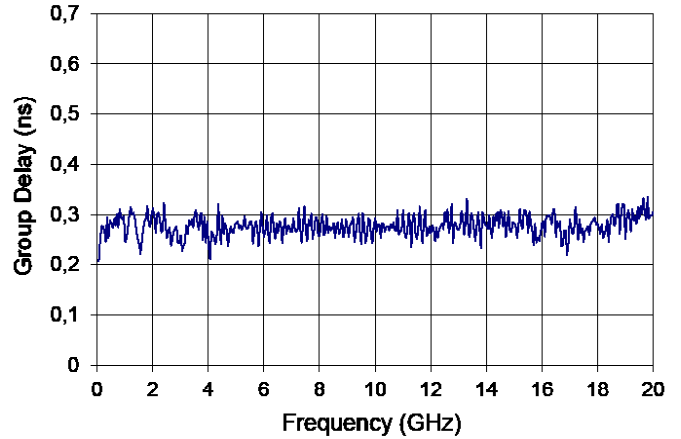

S_{22} Parameter Curve

Conditions: $V_{bias} = 12\text{ V}$, $V_{amp} = 1.2\text{ V}$, $V_{xp} = 0.8\text{ V}$, $I_{bias} = 300\text{ mA}$

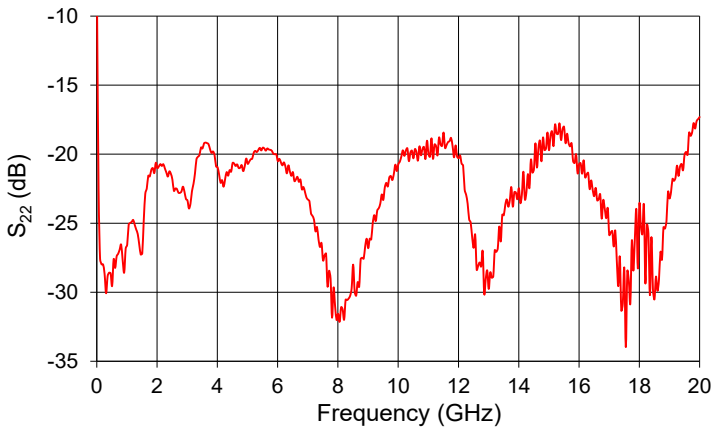

S_{11} Parameter Curve

Conditions: $V_{bias} = 12\text{ V}$, $V_{amp} = 1.2\text{ V}$, $V_{xp} = 0.8\text{ V}$, $I_{bias} = 300\text{ mA}$

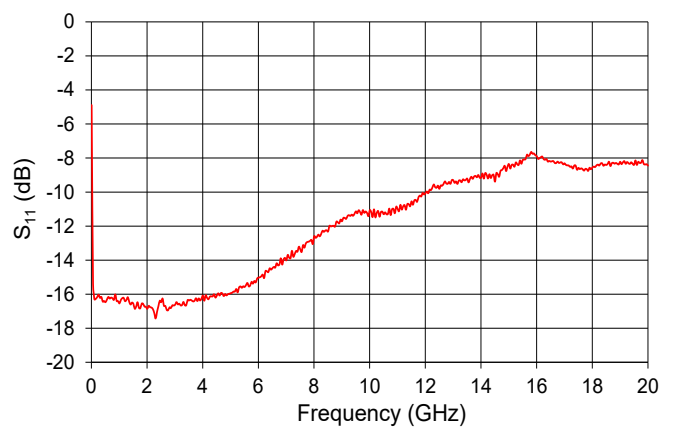

S_{12} Parameter Curve

Conditions: $V_{bias} = 12\text{ V}$, $V_{amp} = 1.2\text{ V}$, $V_{xp} = 0.8\text{ V}$, $I_{bias} = 300\text{ mA}$

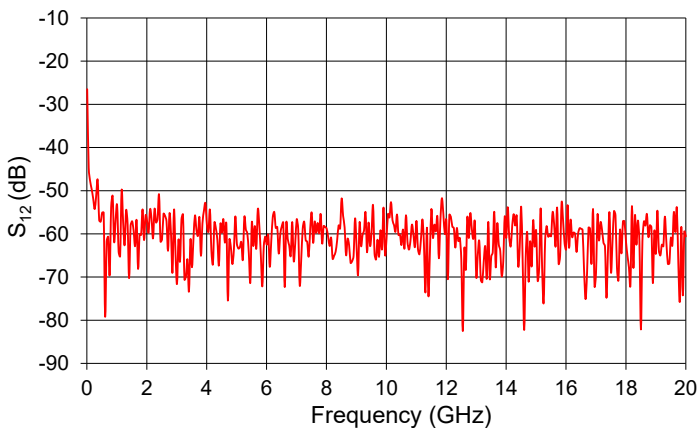

Typical Output Voltage Amplitude vs V_{amp}

Conditions: $V_{bias} = 12\text{ V}$, $V_{xp} = 0.8\text{ V}$, $V_{in} = 0.3\text{ V}_{pp}$

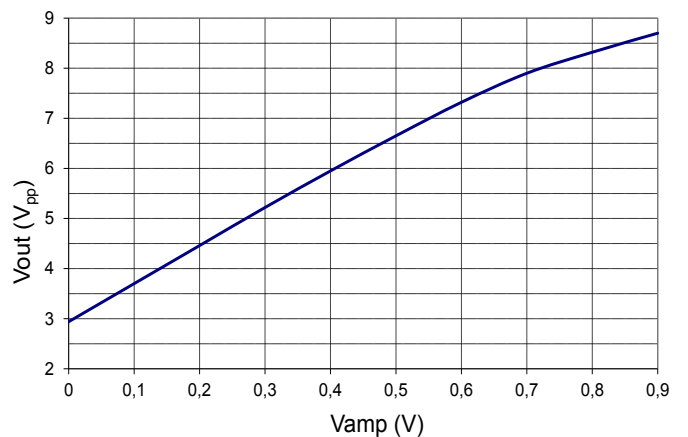

Pulses Measurements

The input electrical signal is generated by Anritsu MP1800A. Input and output signals measured using Keysight 86100D.

Low frequency repetition rate with a short pulse width of PW = 60 ps

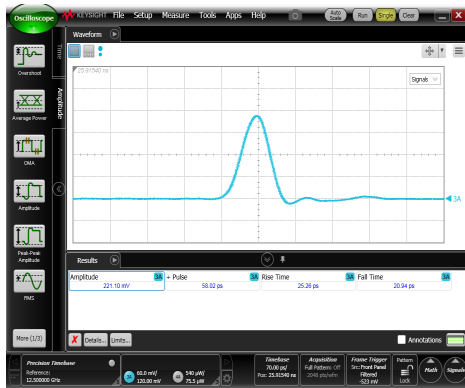

Input signal: Pulse amplitude = 0.22 V_{pp}, Rise time = 24 ps

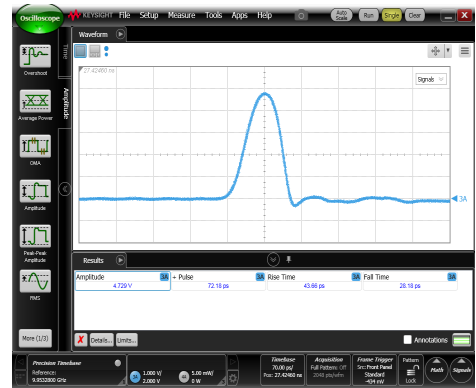

Output response: Pulse amplitude = 4.7 V_{pp}, Rise time = 32 ps

Low frequency repetition rate with a short pulse width of PW = 1 ns

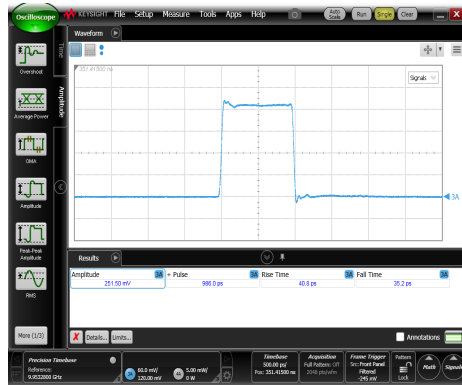

Input signal: Pulse amplitude = 0.25 V_{pp}, Rise time = 32 ps

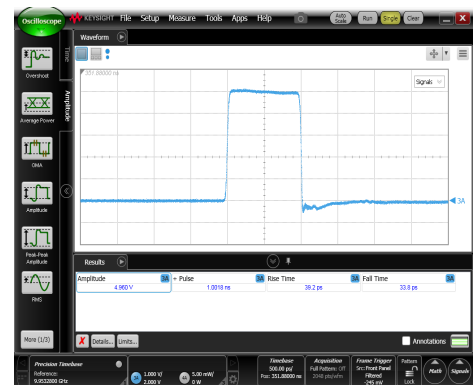

Output response: Pulse amplitude = 5 V_{pp}, Rise time = 32 ps

Low frequency repetition rate with a pulse width of PW = 10 ns



Input signal: Pulse amplitude = 0.25 V_{pp}, Rise time = 32 ps

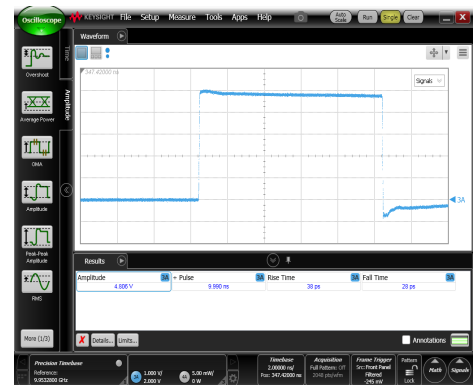

Output response: Pulse amplitude = 4.8 V_{pp}, Rise time = 32 ps

Electrical Schematic Diagram

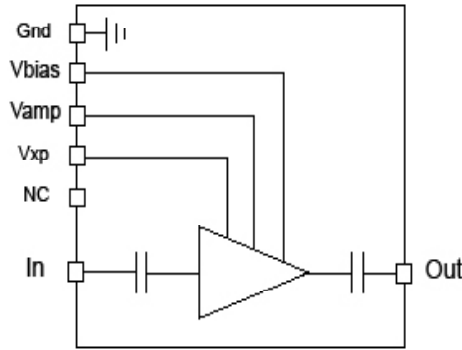

Mechanical Diagram and Pinout

All measurements in mm

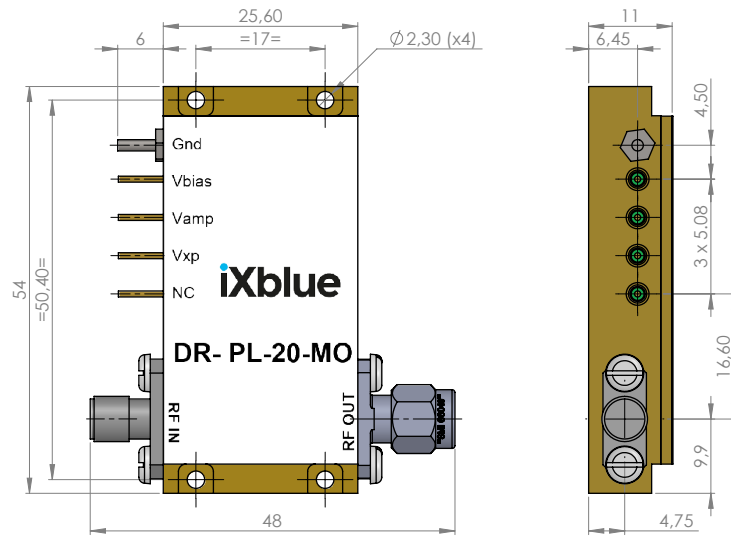

The heat-sinking of the module is necessary. It's user responsibility to use an adequate heat-sink. Refer to page 6 for iXblue recommended heat-sink.

PIN	Function	Unit
IN	RF In	K connector female
OUT	RF Out	K connector male
V_{bias}	Power supply voltage	Set a typical operating specific tion
V_{amp}	Output voltage amplitude adjustment	Adjust for gain control tuning
V_{xp}	Output pulse adjustment	Adjust for pulse adjustment (amplitude and width) tuning

Mechanical Diagram And Pinout With HS-MO2 Heat-sink

All measurements in mm

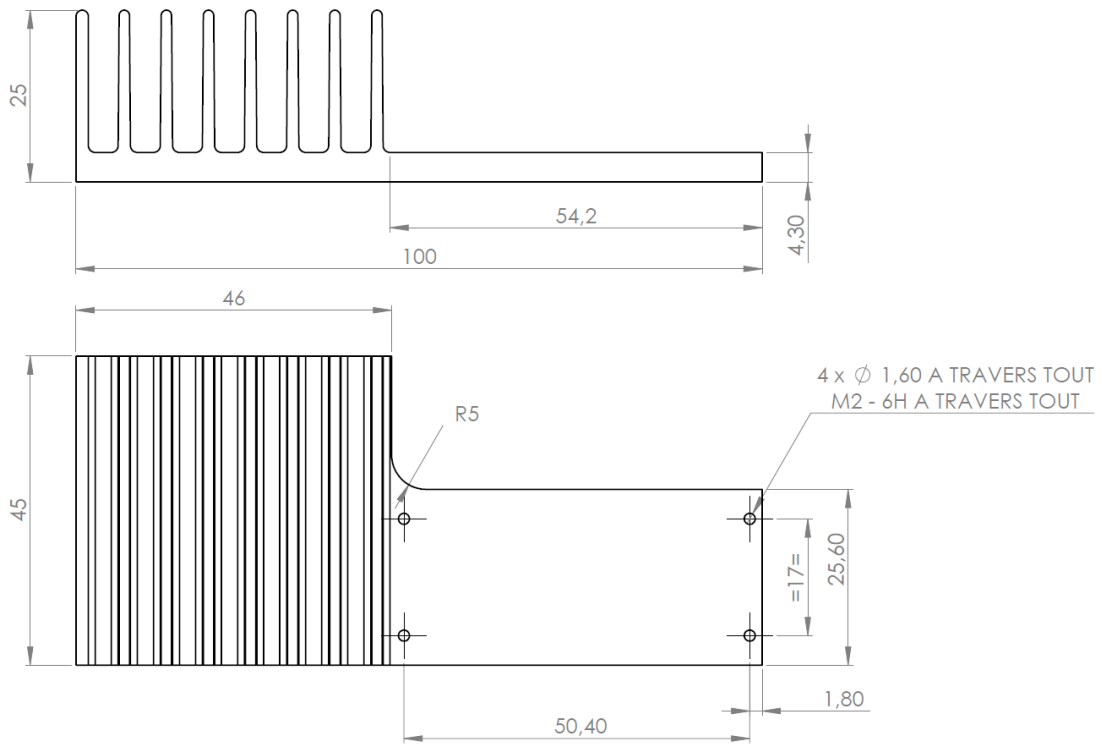
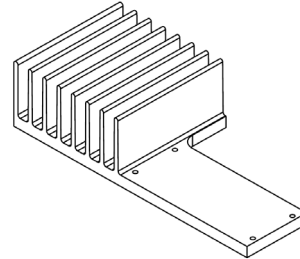

About us

iXblue Photonics produces specialty optical fibers and Bragg gratings based fiber optics components and provides optical modulation solutions based on the company lithium niobate (LiNbO₃) modulators and RF electronic modules.

iXblue Photonics serves a wide range of industries: sensing and instruments, defense, telecommunications, space and fiber lasers as well as research laboratories all over the world.