

Options & Accessories

Light Collecting & Fiber Coupling Systems



Wide-Range Achromatic Condenser PS-2

Designed for collecting light from a sample within a wide spectral range and its effective transmission into an optical fiber or onto an entrance slit of a spectral device.

Consists of two achromatic UV-transparent objectives.

Spectral range:	200nm - 2000nm
Light collection angle:	22°
Front/back flange focal distance:	38.5 mm
Entrance/exit aperture ratio F#:	1:3

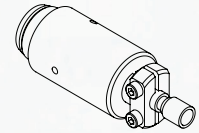
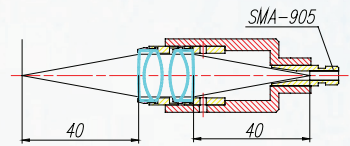

Wide-Aperture Achromatic Condenser PS-3 (*)

Designed for collecting light from a sample within a wide aperture angle and its further transmission into an optical fiber or onto an entrance slit of a spectral device.

Consists of a meniscus and two achromatic objectives.

Spectral range:	
Preferable	400nm-1000nm
Acceptable	400nm-1700nm
Light collection angle:	37°
Front focal length:	29.5 mm
Entrance aperture ratio F#:	1: 1.5
Back focal length:	100 mm
Exit aperture ratio F#:	1: 3.3

*PS-3 allows placing an Edge-filter in 25mm x 3mm holder in the parallel beam between two objectives.

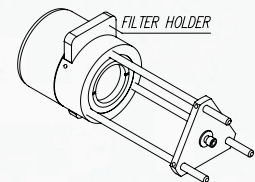
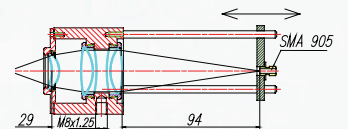

Cassegrain Objective CT

Contains a focusing mirror system and UV-protective glass (BaF2 for IR-version).

Spectral range:	190 nm - 2 μm
	400 nm-8 μm for IR-version
Focal length:	285 mm
Aperture ratio F#:	1:4.4
Focusing range:	∞ ... 3.5 m
Linear field in the image space:	10 mm
Diameter 81 mm, length 165 mm, connector SMA-905	

CT objective can be connected directly to the entrance slit of the M266, M833, MSA-130 monochromators

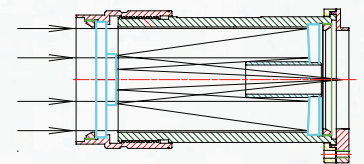

Achromatic Fiber Adapter FA-1

Contains a two-lens achromatic objective (diameter 15mm, focal length 44.5mm).

Spectral range:	200 nm-2000 nm
Aperture ratio F#:	1:3
3D alignment	
SMA-905 connector	

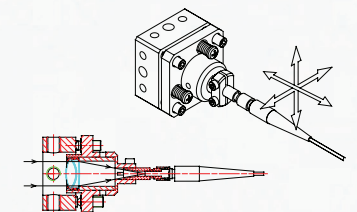

Achromatic Fiber Adapter FA-2

Contains a two-lens achromatic objective (diameter 15mm, focal length 44.5mm).

Spectral range:	200 nm-2000 nm
Aperture ratio F#:	1:3
Axial alignment	
SMA-905 connector	

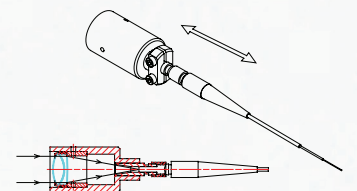

Diffuse Attenuator FA-3

Contains two diffuse UV-silica substrates & SMA-905 connector.

Spectral range:	200 nm-2000 nm
Axial adjustment of the fiber end relative to dispersing elements.	
Diffuse attenuator FA-3 is included into the standard set of supply of the wide-range Wavelength Meter SHR and SHR-IR.	

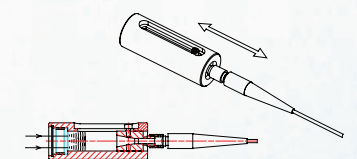

Accessories for liquid handling

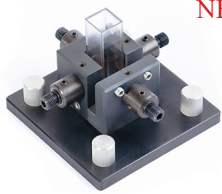

NEW!

Four-position cell holder FA-10 to measure absorption and fluorescence (at 90°)

Designed for a standard cell with 1cm optical path length (*)
Spectral range: 200-2000nm
Contains four collimating lenses and four standard SMA-905 connectors
Possibility to install a filter up to 5 mm thick

* the cell is not included in to the holder delivery set



NEW!

Fiber-optic probe DipProbe for express measurements of absorption in liquids

Spectral range: 200-2000nm;
Contains a Y-shaped optical fiber with two SMA-905 connectors and an interchangeable Tip featuring collimating optics and reflecting mirror.

Light from one of the fibers enters the Tip, is collimated here, passes twice through the absorbing medium with intermediate reflection from the end mirror, and is focused to the second optical fiber to be further delivered to a spectrometer.

Interchangeable Tips DP-5, DP-10, DP-15, DP-20 are completely dismountable. They are consumables.



NEW!

Interchangeable Tips DP-5, DP-10, DP-15, DP-20 for the fiber-optic probe DipProbe

Spectral range: 200-2000nm;
The tip is completely dismountable;
Contains a collimating lens, a reflecting mirror and a liquid-protective ring gasket.
Features high efficiency over the whole operation range, including the UV range starting from 200 nm.

Aperture Matching Systems



Achromatic fiber adapter AFA

Designed to match apertures of an optical fiber and monochromator in order to reduce stray light and optimize light throughput.

Is mounted on the entrance slit of the M266, M833, and MSA-130 monochromators or on the Filter Wheel

Spectral range: 200nm-2000nm
Contains two achromatic objectives and SMA-905 connector

Provides axial alignment of the fiber end and adjustment of the distance between objectives, which allows adjusting output aperture ratio F# within the range from 1:3.5 to 1:8

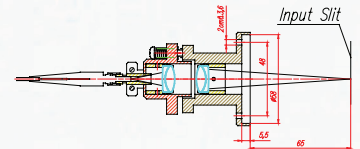

Achromatic Mirror Condenser PS-4

Intended to collect light from a light source to the monochromator input slit. Contains achromatic mirror optics.

Spectral range: 190nm – 2000nm
Light collection angle: 14°
Aperture ratio F#: 1 : 3.1
Front/back flange focal distance: 15mm –75mm (from the PS-4 housing)
Magnification: 0.75X -1.3X
Linear field of view in the object space: 12mm
Height of optical axis: adjustable 65mm – 160mm

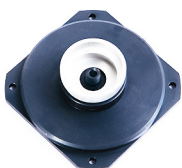
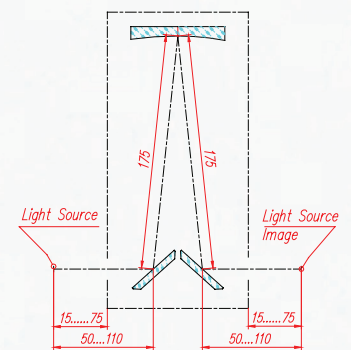

Mechanical Fiber Adapter FA-4

Contains SMA-905 connector and four mounting holes for fixing on a monochromator input/output slit.
Possibility of manual XY alignment of the fiber end relative to the monochromator slit.

