

APPLICATIONS

- Laser Phase / Frequency noise testing
- Interferometric sensor simulation
- Path imbalance interferometer

OPTIPHASE, a leading supplier of ultra-high performance interferometric systems, offers **Fiber Interferometers** for use in precision test and measurement instrumentation as well as fiber sensing systems. These interferometers are driven by our own PZ1 Low-profile Fiber Stretcher with enhanced modulation, through a front panel BNC connector. Michelson and Mach-Zehnder interferometers are available in wavelengths from 1064 to 1550 nm. Each interferometer has a “zero meter” path mismatch which provides flexibility to change the delay length to match varying test applications. The standard length shipped is 50 meters. We also build custom interferometers. Contact us and let us know of your specific requirements.

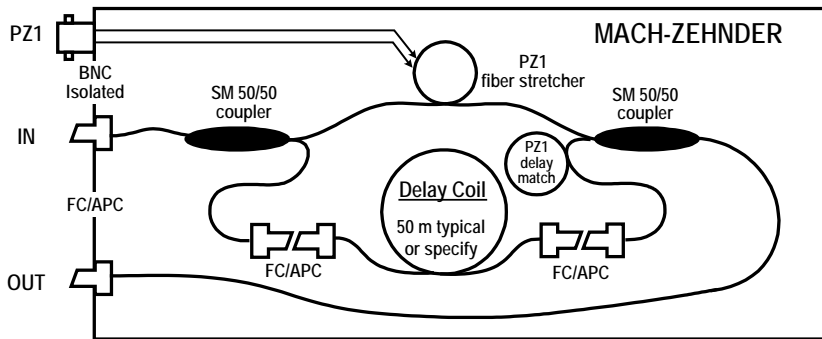
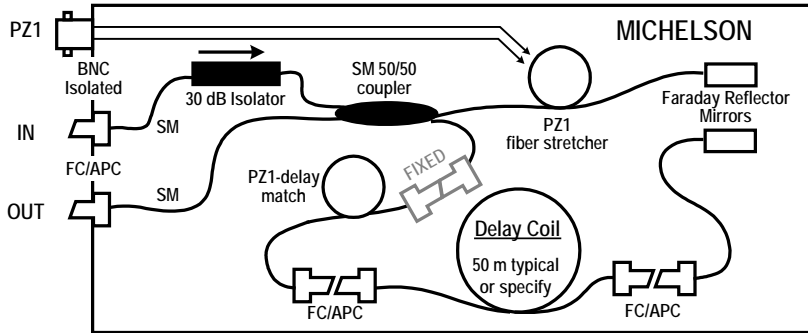

SPECIFICATIONS

INTERFEROMETER	MICHELSON			MACH - ZEHNDER		
Model Number	MFI-10-50	MFI-13-50	MFI-15-50	MZI-10-50	MZI-13-50	MZI-15-50
Operating Wavelength	1064 nm	1310 nm	1550 nm	1064 nm	1310 nm	1550 nm
Modulation						
Modulator Constant	2.5 rad/V	2.0 rad/V	1.6 rad/V	1.2 rad/V	1.0 rad/V	0.8 rad/V
Maximum Voltage Range	± 500V [off resonance, 1000V P-P]					
Maximum Frequency Range	See chart page 2, specified at 1550 nm					
Modulator Interface	BNC			BNC		
Path Mismatch [without delay]	Zero meter +/- 10 cm			Zero meter +/- 10 cm		
Fiber Type	HI-1060	SMF28e+		HI-1060	SMF28e+	
Optical Interface	FC/APC			FC/APC		
Optical Power Limit	250 mW			500 mW		
Dimensions & Weight	10.2"L X 6.3"W X 3.5"H"; 6 lbs.			10.2"L X 6.3"W X 3.5"H"; 6 lbs.		
Delay Coil						
Delay length range	0.5 meters to 1,000 meters			0.5 meters to 1,000 meters		
Standard length	50 meters			50 meters		
Fiber Type	HI-1060	SMF28e+		HI-1060	SMF28e+	
Connectors	FC/APC			FC/APC		
Optional delay coils	Substitute "50" in the model number with desired length in meters					



LASER PHASE / FREQUENCY NOISE TESTING

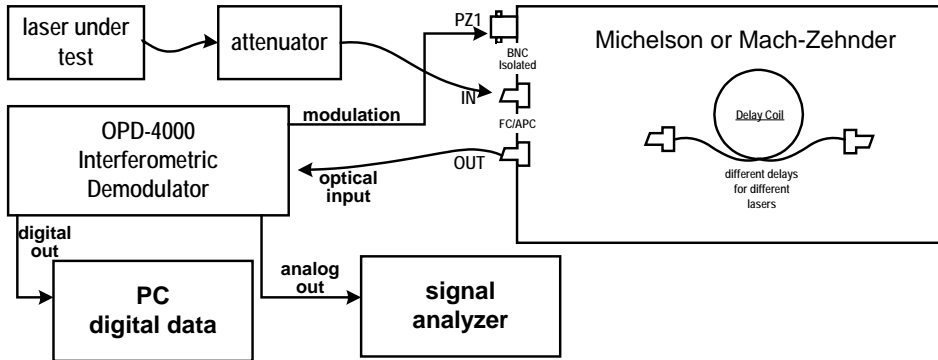

Laser under test is input to interferometer, which is set to the appropriate optical path mismatch by selection of the delay line which may be user installed or changed. OPD-4000 modulation output is applied to the PZ1 fiber stretcher input. OPD-4000 phase measurement output is selected as either digital or analog. Digital data is post processed. Analog data is made available to signal analyzer.

LASER PHASE / FREQUENCY NOISE TESTING 2

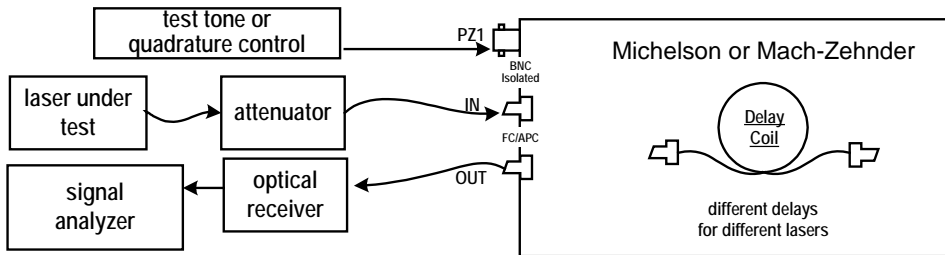

Laser under test is input to interferometer, which is set to the appropriate optical path mismatch by selection of the delay line which may be user installed or changed. Voltage control is applied to the PZ1 fiber stretcher input to maintain quadrature bias. Output optical signal is applied to an optical receiver. Receiver output to a signal analyzer or digitizer / recorder.

FIBER INTERFEROMETRIC SENSOR SIMULATOR

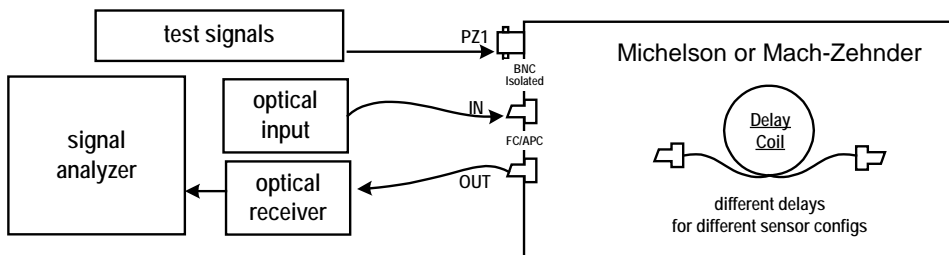

Optical input applied to represent the optical source of a fiber interferometric sensor. Delay coil is selected to be length of sensor to be simulated. Test signals applied to the PZ1 fiber stretcher. Output optical signal is applied to an optical receiver. Receiver output to a signal analyzer or digitizer / recorder.

MODULATION FREQUENCY RESPONSE OF PZ1 FIBER STRETCHER (Single Pass)

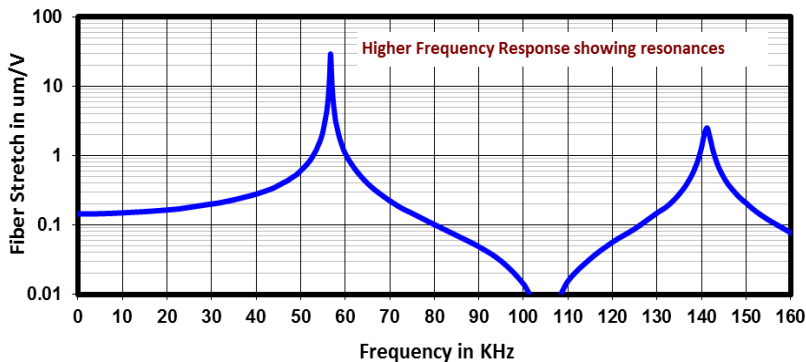

How to drive PZ1 stretchers

The equivalent circuit for the PZ1 fiber stretcher is shown below. At frequencies sufficiently below the first resonance (dc - 40 KHz) the effective impedance is capacitive, defined by $C_0 + C_1 + C_2$, being approximately 2 nF. At 40 KHz, the magnitude of the impedance of this capacitance is 2000 ohms. Most laboratory equipment or circuitry can be used to drive this load with no modifications.

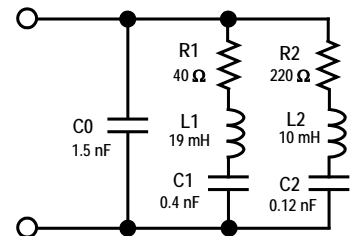

PZ1 Series Equivalent Impedance

DC - 10 KHz is approx $C_0 + C_1 + C_2$ (= 2 nF)
 First Resonance (57 KHz) defined by R1, C1, L1
 Second Resonance (140 KHz) defined by R2, C2, L2