

Handyscope HS6 DIFF

250 MHz bandwidth, 1 GS/s, 14 bit USB 3.0 PC oscilloscope

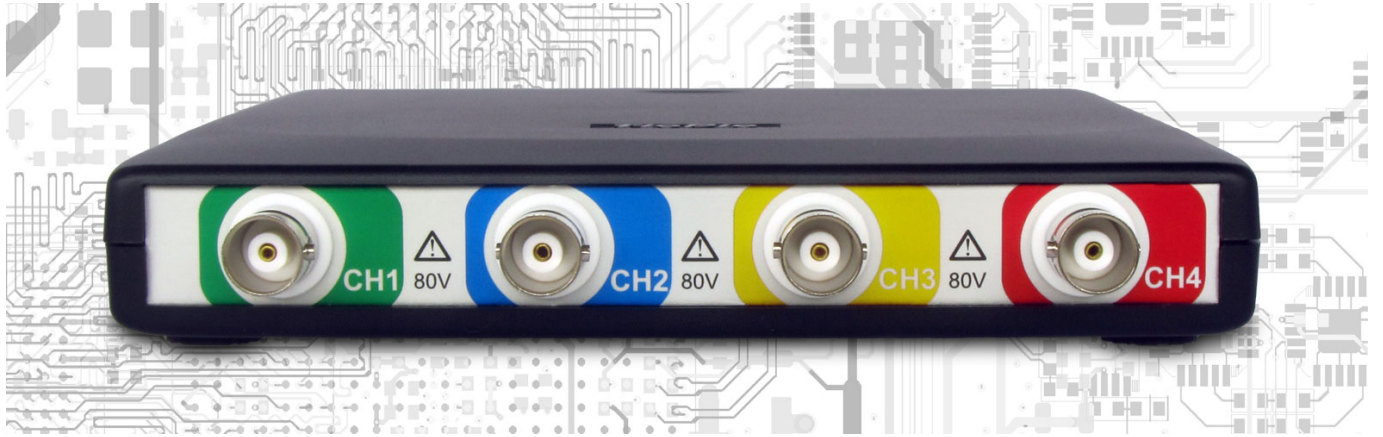

The high resolution USB oscilloscope with the lowest noise and high sensitivity with 4 differential input channels and an amazing 256 million point record length that can be filled with a sample rate of 1GS/s. This is the most powerful, portable and versatile USB 3.0 PC oscilloscope, EMI pre compliance tester, high resolution multimeter and more... incorporating innovative technology such as **SureConnect**, **SafeGround** and CMI interfacing and a SuperSpeed USB 3.0 connection.

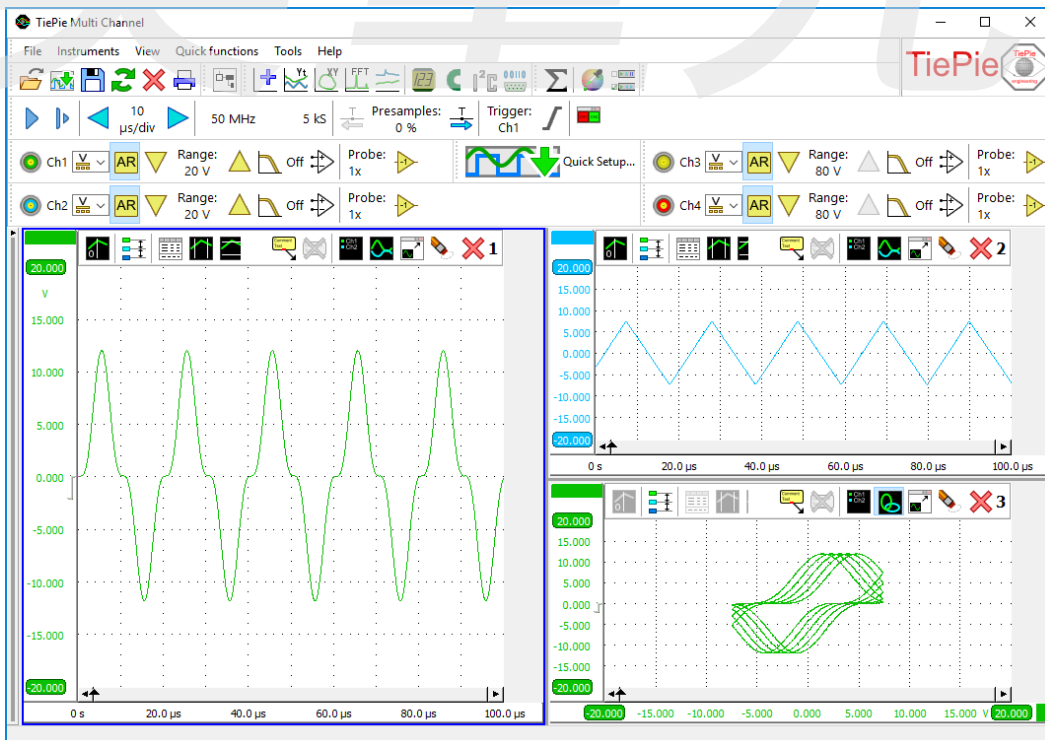

Step into the Next Generation of High Performance USB 3.0 PC oscilloscopes.

The best way to experience that superiority of the Handyscope HS6 series USB 3.0 PC oscilloscopes is to use one.

See www.tiepie.com/HS6D



Handyscope HS6 DIFF, the USB 3.0 PC oscilloscope packed with technology

Key facts of this high sensitivity best in class USB 3.0 oscilloscope:

- 1 GSamples per second sample rate USB 3.0 oscilloscope
- 14-16 bit High Resolution, 256 times more amplitude resolution than an 8 bit oscilloscope
- Lowest noise USB oscilloscope in the market
- DC Accuracy of 0.25 % and 0.1 % typical
- Differential inputs. Each input can be switched to single ended with SafeGround protection
- SureConnect connection test on each channel
- Extremely accurate EMI pre compliance tester with special EMI probe set
- CMI interfacing to combining multiple instruments for fully synchronized measuring
- Up to 250 MHz analog bandwidth
- Switchable hardware-based bandwidth limiter of 150MHz, 100MHz and 50MHz
- Highly accurate 1 ppm timebase
- Super zoom up to 256 Million samples deep buffer memory
- Spectrum analyzer with 32 million bins
- High Performance Digital Multimeter (DMM)
- Very fast 200 MSamples per second USB streaming Data logger
- Protocol analyzer
- Quick Setup fast to work with all types of measurements
- I/O block to build your own measurement
- An API and SDK to build your own software
- SuperSpeed USB 3.0 connection
- Free software and firmware updates
- 3 years warranty, 5 years optional

The Handyscope HS6 DIFF provides the best that is available in industry, for a limited budget. The flexibility and quality that the Handyscope HS6 DIFF offers is unparalleled by any other oscilloscope in its class.

Models

The Handyscope HS6 DIFF is available in five different models with an extended memory option (XM), with EMI option (E), with SafeGround option (G) and with optional SureConnect connection test and resistance measurement (S).

Handyscope HS6 DIFF model	1000	500	200	100	50
Maximum sampling rate	1 GS/s	500 MS/s	200 MS/s	100 MS/s	50 MS/s
Maximum streaming rate	200 MS/s	100 MS/s	40 MS/s	20 MS/s	10 MS/s
Maximum record length	standard model	1 MS	1 MS	1 MS	1 MS
	XM option	256 MS	256 MS	256 MS	256 MS

The right choice

The Handyscope HS6 DIFF series USB 3.0 PC oscilloscope, fully packed with technology for all your advanced measurements now and in the future.

This small, light and portable USB oscilloscope captures and displays significantly more signal to solve your measurement problem. Because of this, the Handyscope HS6 DIFF series is an ideal choice for demanding measurements.

Expand your channels with the CMI interface and build a comprehensive measuring system in seconds with a lot more than 4 channels and also add AWG generators such as the Handyscope HS5.

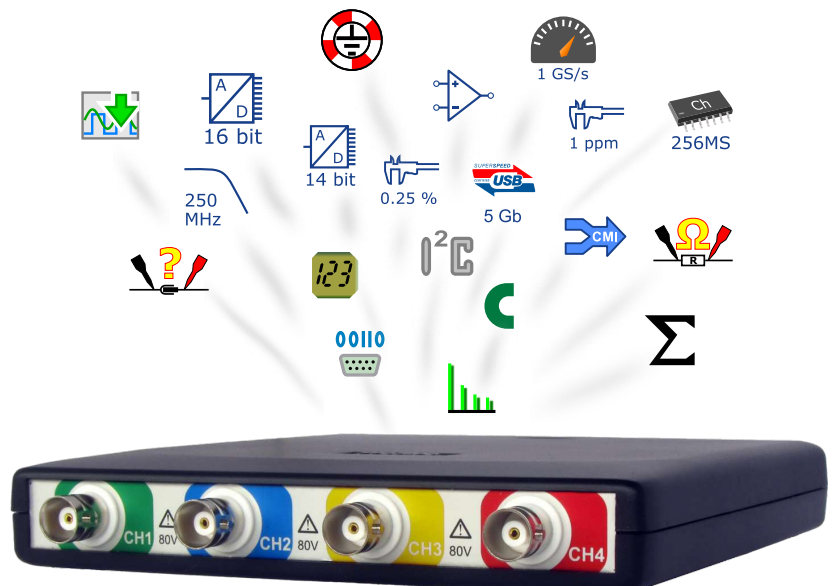

Differential / single ended switchable inputs with SafeGround protection



SafeGround gives the possibility to use the oscilloscope inputs both as single ended and as differential. When **SafeGround** is active and you accidentally create a wrong connection that causes a short circuit, **SafeGround** will disconnect the ground of the input channel without damaging the oscilloscope or PC. You can therefore simply switch from a differential input to a single ended input without worrying if anything will damage because of a short circuit current*. The Handyscope HS6 DIFF is the only oscilloscope in the world with this unique **SafeGround** protection. And as you all know, a connection mistake is easily made, which will now have no more strange and financial consequences because of **SafeGround** as the short circuit current is limited thanks to **SafeGround**.

Background: The advantage of an oscilloscope with differential inputs is that there are no connections between the channels and with the ground of the computer. It is therefore not possible to create a short circuit. With **SafeGround** enabled you can connect a standard 1:10 probe to your channel, this is not possible with a standard differential channel of other oscilloscope manufacturers. Sometimes it is also required to perform a single ended measurement, but then there is a risk of a short circuit.

When you do want to measure with a single ended input, your input is connected to the ground of your oscilloscope and your computer (the alligator clip of your probe is directly connected to ground). The input channels are also connected to each other. When you connect the alligator clip of your probe accidentally to a point in your test subject that is not at ground level but to a point with an elevated voltage, a short circuit current will flow through your probe, oscilloscope and computer. This can cause serious damage to the test subject, the scope and the computer. **SafeGround** avoids this and safes you a lot of misery. **SafeGround** can be enabled individually for each channel of the Handyscope HS6 DIFF.

* Maximum short circuit current is 500 mA.

SureConnect connection test on each channel



TiePie engineering is the first oscilloscope manufacturer to implement **SureConnect** technology. While measuring, the revolutionary **SureConnect** technology checks in real time whether a test probe is in physical and electrical contact with the test subject.

Assuring a good connection of a probe with a test subject may not always be easy. The subject under measurement may be dirty, oxidized or an (invisible) protective layer may be present. Or, the test subject may be hidden, making visible contact confirmation impossible. Also, capacitive coupling between test probe and test subject can result in measuring a distorted version of the actual signal, wrongly suggesting a connection. Simply activate the **SureConnect** connection test and you know whether there is contact or not.

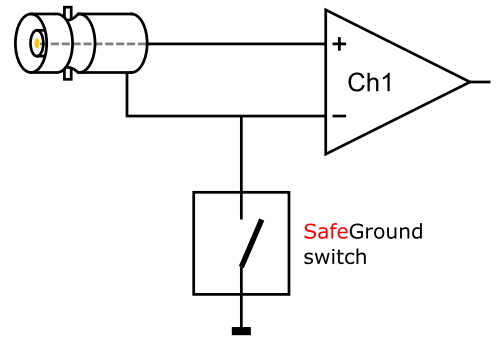

SafeGround protects your scope, your computer and your circuit under test against accidental wrong ground connections.

SafeGround properties:

- Low switch off current
- High speed switching
- High voltage protection
- **SafeGround** on each channel



SureConnect: no more doubt whether your probe doesn't make contact or there really is no signal.

See a demonstration of **SureConnect** at <https://youtu.be/MinFpSFvtIY>

Resistance measurement on each channel



Many sensors are based on variable resistors. Use your Handyscope HS6 DIFF in the resistance setting to test them, no more need to take a separate ohm meter. Resistance values can be displayed as a number, but it is also possible to display the resistance variation in time, in a graph: an **Ohm scope**.

The Ohm scope uses the same inputs as the oscilloscope. Changing the measure leads is not required. The advanced protection against over voltage ensures that the Ohm scope withstands high voltages.

A typical application is to create resistance graphs of special resistors like NTCs and PTCs. Use e.g. channel 1 to measure the resistance of the PTC and channel 2 to measure the temperature. An XY plot will then show the resistance variation as a function of the temperature.

EMI pre compliance tester



The powerful capabilities of the Handyscope HS6 DIFF EMI analyzer give the user the possibility to quickly perform a good EMI compliance test. With this cost effective test, time and money are saved by avoiding extra visits to expensive EMC testing facilities. The supplied TP-EMI-HS6 probe set contains three magnetic field (H field) probes and one electric field (E field) probe. The tripod ensures that the probes can be positioned properly at the object under test.

The Handyscope HS6 DIFF EMI analyzer has a very low resolution bandwidth of up to 7.45 Hz (at a span of 500 MHz), which is unique in its class. As a result, details in each part of the spectrum can be analyzed thoroughly.

To clarify: a resolution bandwidth of 7.45 Hz at a span of 500 MHz gives a total of 67,108,864 spectral components. When your display is 1920 pixels wide, you require 34,952 displays to show the full spectrum 1:1. 34,952 displays with a width of 50 cm (23" diagonal) each, gives a total display width of 17.47 km (10.85 mile)! So, if you zoom in 35,000 times, you will get the spectral components 1:1 on your display. That is exceptional for an EMI analyzer and it makes each frequency component very well visible.

The Handyscope HS6 DIFF EMI analyzer consists of a Handyscope HS6 DIFF-1000 with **option E** installed. Option E also requires options **XM** (extended memory) and **G** (SafeGround) to be installed. With option E installed, the Handyscope HS6 DIFF has an extra ground connection next to the Channel 1 input. Option E also includes the EMI probe set TP-EMI-HS6.

The EMI probe set TP-EMI-HS6 is a complete set of probes, conveniently packed in a carry case. The set contains three differently sized H field probes and an E field probe. To connect the probes to the scope, a short semi flexible antenna cable and a long flexible antenna cable are included. For proper grounding and termination, a grounded 50 Ohm terminator is also included. The tripod allows exact positioning of the probe near the test subject.

Advantages of the Ohm scope are:

- Capture fast resistance changes in a graph.
- Detect and locate carbon track defects in a variable resistor.



Extra ground connection next to the Channel 1 input



The EMI probe set TP-EMI-HS6.

Combining multiple instruments for fully synchronized measuring



The Handyscope HS6 DIFF is equipped with the sophisticated CMI bus, allowing to connect multiple Handyscope HS6 DIFF's to each other, which then can be used as a combined instrument. All instruments will measure at the same sample frequency (0 ppm deviation!) Apart from a synchronization bus, the CMI also contains a trigger bus and a detection bus. Multiple Handyscope HS6 DIFF's can be connected to each other using a coupling cable. The maximum number of instruments is only limited by the number of available USB ports.

When the Multi Channel software is started, the coupled Handyscope HS6 DIFF's are identified and automatically combined to a larger instrument. Both the synchronization bus and the trigger bus are automatically terminated at both ends with the correct impedance. Placing terminators is not required by the user. Combining the instruments is fully automatic. This unique possibility to create e.g. a 12 channel instrument is only available with the Handyscope HS6 DIFF and no other USB 3.0 oscilloscope.

The Handyscope HS5 (www.tiepie.com/HS5) is also equipped with the CMI bus. Coupling a Handyscope HS6 DIFF with a Handyscope HS5 gives a 6 channel measuring system with Arbitrary Waveform Generator.

See the CMI bus in action at https://youtu.be/20L_exU3Reg

Highly accurate 1 ppm oscilloscope timebase



The time base accuracy of the Handyscope HS6 DIFF is 25 to 100 times better than the comparable instruments of the competition. With a time base accuracy of 1 ppm, frequency and timing can be measured very accurately.

Very fast 200 MSamples per second streaming Data logger



When unlimited deep memory is required, it is possible to stream the measured data directly to disk. The Handyscope HS6 DIFF is capable of streaming up to 200 million samples per second, at 12 bit resolution, when measuring 1 channel. When measuring at 16 bit resolution on all four channels, streaming measurements can be performed up to 6.25 MS/s. Using streaming measuring, difficult problems can be measured easily and traced back and analyzed.



With five Handyscope HS6 DIFF's and four coupling cables you get a 20 channel oscilloscope with a high resolution of 12 bits and a maximum sampling rate of 1 GS/s in a matter of seconds (no special software or hardware modifications required).

Coupling multiple instruments to a large combined instrument does not affect the time base accuracy, the timing deviation between the coupled instruments is 0 ppm.

High amplitude resolution, 256 times more than a standard oscilloscope



A standalone oscilloscope usually has a low resolution of 8 or 9 bit, combined with a limited display of just 5.7" or 8.5", displaying the measured signals in their actual resolution. Zooming in will then not reveal more details.

The Handyscope HS6 DIFF has high resolutions of 14 and 16 bit, making it a truly high precision oscilloscope. With a high resolution, the original signal is sampled much more accurate, the quantization error is much lower.

To display a signal measured with the Handyscope HS6 DIFF high resolution oscilloscope at the same level of detail as the standalone oscilloscope, the display can be 256 times larger. Viewing the signals on a 24" monitor immediately gives a very detailed impression of the signal. The smallest deviations are very well visible and because of the high resolution, it is still possible to zoom in and reveal additional details.

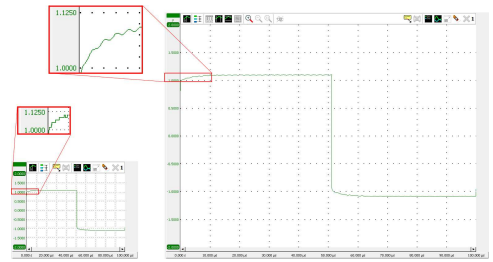

Shown are two displays, both showing a measurement of the same signal. The left display size corresponds to a size comparable to a standalone oscilloscope; at 8 bit resolution, zooming will not reveal more details. The right display corresponds to a maximized window on a standard PC screen; at 14 bit resolution, zooming will still reveal more details.

Mega deep memory of up to 256 MSamples per channel



When measuring at high sample rates, a long record length is a must, otherwise the acquisition buffer is full before the signal is measured. Where most oscilloscopes have 2.5 kSamples or 100 kSamples memory, the Handyscope HS6 DIFF has up to 256 MSamples memory per channel, depending on the selected resolution and the number of active channels. When measuring at 14 bit resolution and all four channels, the available memory is 32 MSamples per channel. This gives the user 300 to 10000 times more memory. The advantage of deep memory is that once-only fast phenomena can be measured accurately or complete serial communication signal blocks like CAN Bus signals can be measured all at once.

To the right, a 256 million samples long measurement is shown. The same signal is shown three times in different zooming factors, the bottom graph shows just 256 ns of the total 356 ms, a zoom factor of 1 million. It still provides enough detail for accurate signal analysis.

In the USB 3.0 spectrum analyzer, the deep memory gives the advantage that a large dynamic range is created which sets troubleshooting in the frequency domain as a new standard.

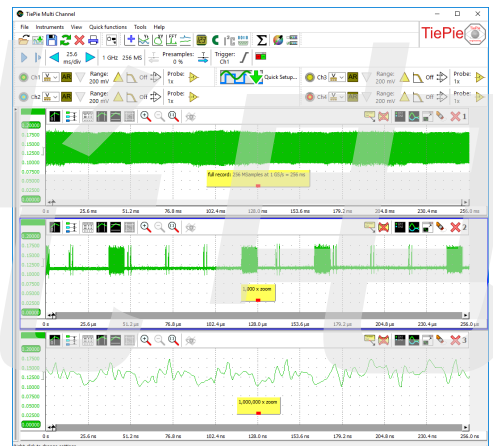

The unlimited super zoom feature of the Handyscope HS6 DIFF allows to zoom in up to one individual sample, no matter what record length was selected.

Switchable hardware-based bandwidth limiter



It seems reasonable to assume that more bandwidth is better, but a wider bandwidth gives more noise. To reduce your noise you can switch the bandwidth limiter on. Enabling the bandwidth limit also avoids under sampling. When a lot of noise appears on your signal and triggering becomes unstable, switching the bandwidth limit on will give a stable triggering. The bandwidth limit can be enabled for each channel individually. The frequency of the bandwidth limiter depends on the Handyscope HS6 DIFF model (150 MHz, 100 MHz, 50 MHz or 75 MHz, 50 MHz, 25 MHz).

▼ Range: 200 mV	▲ Off	⇒ Probe: 1x
▼ Range: 200 mV	▲ 150 MHz	⇒ Probe: 1x
▼ Range: 200 mV	▲ 100 MHz	⇒ Probe: 1x
▼ Range: 200 mV	▲ 50 MHz	⇒ Probe: 1x

High performance USB 3.0 digital multimeter



With the high resolution of 16 bits, the Handyscope HS6 DIFF can be used as a comprehensive and accurate high performance digital multimeter with good specifications (like e.g. RMS, peak-peak, Max, Min, Mean, Variance, Standard deviation, Frequency, duty cycle, Crest factor, Rise time, Fall time, dBm, etc.). Both numerical and gauge displays are available. The stable and very accurate time base of the Handyscope HS6 DIFF of 1ppm make very accurate frequency and time measurements possible. These qualities make an extra multimeter or frequency counter redundant and make the Handyscope HS6 DIFF unique in its class.

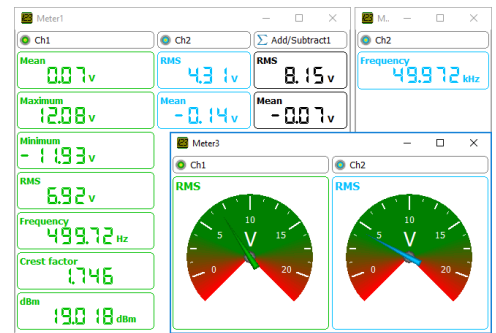

Highest DC accuracy in the industry of 0.1 % typical

Troubleshooting in the frequency domain

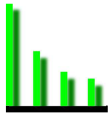

The Handyscope HS6 DIFF definitely brings an end to the idea that spectrum analyzers are expensive, hard to control and difficult to understand. The large flexibility of the spectrum analyzer makes it not just suitable for measuring high frequency signals of transmitters and receivers. A spectrum analyzer displays frequency along the X axis and along the Y axis the magnitude of the signal is displayed. This is called a frequency domain display.

When troubleshooting, usually an oscilloscope is used. But when the disturbance is small in amplitude and contains many frequencies, these signals are badly visible on an oscilloscope. They appear like noise signals. But, when these signals are viewed in the frequency domain, a much better overview is presented of the disturbance signals that are present and which frequencies they contain.

When e.g. measurements are performed on a system that contains switch mode power supplies, the disturbances caused by a power supply are easily detected by measuring in the frequency domain. The switch frequency of the switch mode power supply is measured by holding the probe close to the inductor of the power supply. This unique switch frequency is now known and can be stored in a reference channel. When this frequency is also measured at other locations in the system, the frequency is caused by the power supply. Precautions can be made to suppress the disturbing signal from the switch mode power supply. The suppression can be measured directly by the Handyscope HS6 DIFF USB 3.0 spectrum analyzer.

Because the Handyscope HS6 DIFF measures with a very high resolution in the frequency domain, disturbances can be detected and analyzed at one tenth of a Hertz accuracy. Up to 64 million frequency components can be displayed in a graph. Because of the high resolution of the Handyscope HS6 DIFF (14 and 16 bit resolution and up to 128 MSamples), small disturbances can be easily detected. When a precaution is made to suppress the disturbance, its effectiveness can immediately be checked with the Handyscope HS6 DIFF. With the high resolution and the large memory of the Handyscope HS6 DIFF, a spectrum with a dynamic range of more than 120 dB can be measured. This is unique in its class. With this large dynamic range, distortion measurements can be well performed.

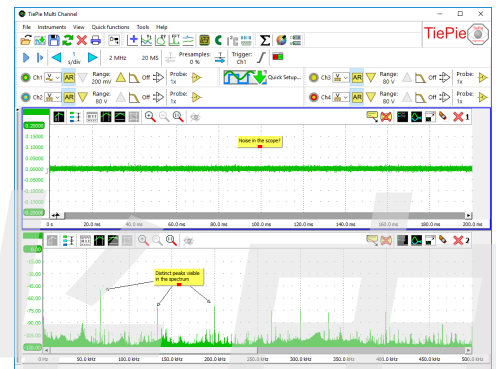

A spectrum with 10 million points and a real time bandwidth of 0-250 MHz, gives you a bin width of 25 Hz and a pulse detection of 2 nsec.

This method of troubleshooting is only possible (and unique for the Handyscope HS6 DIFF) because the Handyscope HS6 DIFF contains:

- 250 MHz bandwidth
- 14 and 16 bit resolution
- up to 128 Million samples memory
- very fast FFT calculations

Protocol analyzer

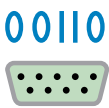

The various serial protocol analyzers of the Handscope HS6 DIFF can be used to analyze and debug serial data buses. The data is displayed in an elaborate table with information on the serial data. Locating "wrong" data packets has become very easy. For each developer or service technician this is a welcome option. Protocol analyzers for CAN bus data, I²C communication and various other serial data communications are available.

To the right, decoded CAN bus messages are shown.

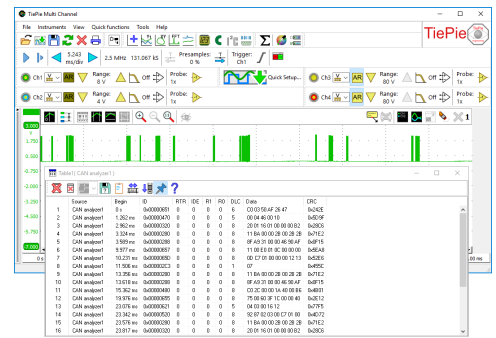

Fast to work with the Handscope HS6 DIFF and Quick Setups



To simplify setting up measurements, the Multi Channel software contains a large number of Quick Setups, for almost any application. A Quick Setup contains the basic settings for a specific measurement as well as additional information regarding the selected Quick Setup, like e.g. how the instrument and/or accessories need to be connected. Quick Setups can also contain reference signals. After loading the Quick Setup, that specific measurement can be performed and if needed, small adjustments to the setup can be made.

The Quick Setups are carefully organized in a tree structure, ordered by application. Just a few mouse clicks allow to perform a complex measurement.

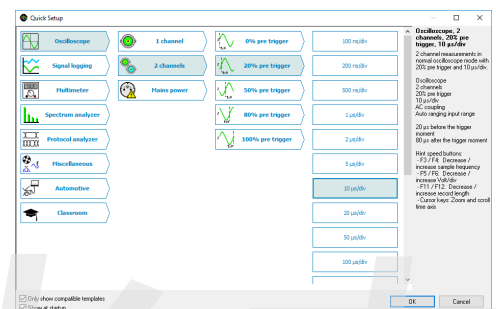

Sophisticated mathematics for in-depth signal analysis



The Multi Channel software for the Handscope HS6 DIFF offers a large variety of mathematical operations like e.g. adding, subtracting, multiplying, dividing, integrating, differentiating, determining the square root, determining the logarithm, etc. These mathematical operations are available in the form of processing blocks and can be used to process the measured signals and reference signals. Besides the basic mathematical operations, there are also several processing blocks to perform more complex operations on the data, like determining minimum or maximum values, limiting to specified range, averaging, filtering, applying gain and offset, resampling etc.

Combining these mathematical processing blocks gives unrivaled possibilities in constructing complex mathematical operations to analyze your measurements thoroughly and obtain all the information you need from your data. The results can be displayed in graphs, numeric displays and tables and can be written to disk in various common file formats.

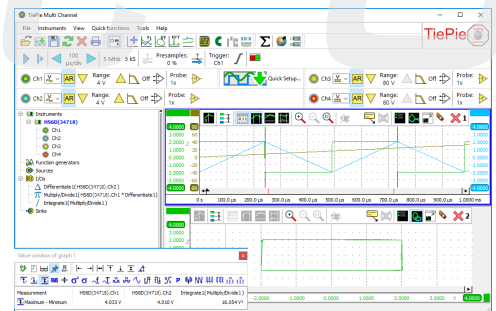

This measurement determines the area of an XY graph, using multiplying, integrating and differentiating I/O's. The area is indicated in the Value window: 16 V².

Σ Add or subtract signals

π Multiply or divide signals

$\sqrt{\quad}$ Determine the square root of a signal

$|x|$ Determine the absolute value of a signal

Δ Differentiate a signal

\int Integrate a signal

\log Determine the logarithm of a signal

\uparrow Apply gain and offset to a signal

\downarrow Apply a low pass filter to a signal

\bar{x} Average a number of consecutive measurements

\wedge Limit the signal magnitude

\downarrow Resample a signal to a different size

The mathematical processing blocks give unrivaled possibilities in constructing complex mathematical operations.

Ease of use

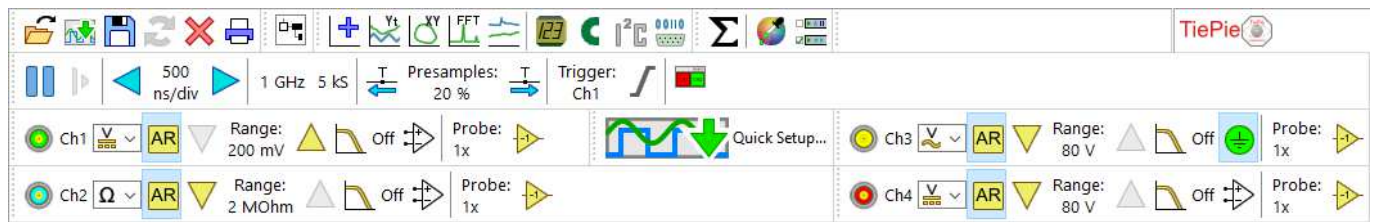

The convenient toolbars offer many ways to control the Handyscope HS6 DIFF. The toolbars are fully customizable to meet the user's demands. The size of the toolbar buttons can be changed to simplify touch screen control. There are toolbars available for common operations like saving or recalling measurements, for each opened instrument, for each channel and for the quick functions. Using quick functions, complex measurements can be performed immediately by a single click.

- Open the Quick Setup screen
- Create an Yt oscilloscope
- Create a data logger
- Create an I²C analyzer
- Select a color scheme

- Hide/show the Object Tree
- Create an XY oscilloscope
- Create a multi meter
- Create a serial analyzer
- Select a toolbar scheme

- Create a new graph
- Create a spectrum analyzer
- Create a CAN Bus analyzer
- Create a math channel

With the cursor measurements, individually for each graph, many signal properties can be determined.

- Sample value at the left cursor
- Sample value at the right cursor
- Value difference between right and left cursor
- Value at the top cursor
- Value at the bottom cursor
- Value difference between top and bottom cursor
- Slope between the cursors
- Maximum signal value
- Minimum signal value
- Top-bottom value
- RMS value of the signal
- Mean value of the signal
- Variance of all signal values
- Standard deviation of all signal values
- Frequency of the signal
- Period time of the signal
- Duty cycle of the signal
- Crest factor of the signal
- Rise time of the signal
- Fall time of the signal
- Slew rate of the signal
- Number of periods
- Number of pulses
- Number of rising/falling edges
- dBm value of the signal
- Power of the signal

Specifications

Acquisition system						
Number of input channels	4 analog					
CH1, CH2, CH3, CH4	Isolated male BNC					
Maximum sampling rate	HS6 DIFF-1000	HS6 DIFF-500	HS6 DIFF-200	HS6 DIFF-100	HS6 DIFF-50	
8 bit						
Measuring one channel	1 GS/s	500 MS/s	200 MS/s	100 MS/s	50 MS/s	
Measuring two channels	500 MS/s	200 MS/s	100 MS/s	50 MS/s	20 MS/s	
Measuring three or four channels	200 MS/s	100 MS/s	50 MS/s	20 MS/s	10 MS/s	
12 bit						
Measuring one channel	500 MS/s	200 MS/s	100 MS/s	50 MS/s	20 MS/s	
Measuring two channels	200 MS/s	100 MS/s	50 MS/s	20 MS/s	10 MS/s	
Measuring three or four channels	100 MS/s	50 MS/s	20 MS/s	10 MS/s	5 MS/s	
14 bit						
Measuring one channel	100 MS/s	50 MS/s	20 MS/s	10 MS/s	5 MS/s	
16 bit						
Measuring one channel	6.25 MS/s	3.125 MS/s	1.25 MS/s	625 kS/s	312.5 kS/s	
Maximum streaming rate ¹	HS6 DIFF-1000	HS6 DIFF-500	HS6 DIFF-200	HS6 DIFF-100	HS6 DIFF-50	
When connected to	USB 3.0	USB 3.0	USB 2.0	USB 3.0 / 2.0	USB 3.0 / 2.0	
8 bit						
Measuring one channel	200 MS/s	40 MS/s	100 MS/s	40 MS/s	20 MS/s	10 MS/s
Measuring two channels	100 MS/s	20 MS/s	50 MS/s	20 MS/s	20 MS/s	10 MS/s
Measuring three or four channels	50 MS/s	10 MS/s	25 MS/s	10 MS/s	5 MS/s	2.5 MS/s
12 bit						
Measuring one channel	100 MS/s	20 MS/s	50 MS/s	20 MS/s	20 MS/s	10 MS/s
Measuring two channels	50 MS/s	10 MS/s	25 MS/s	10 MS/s	10 MS/s	5 MS/s
Measuring three or four channels	25 MS/s	5 MS/s	12.5 MS/s	5 MS/s	5 MS/s	2.5 MS/s
14 bit						
Measuring one channel	100 MS/s	20 MS/s	50 MS/s	20 MS/s	20 MS/s	10 MS/s
Measuring two channels	50 MS/s	10 MS/s	25 MS/s	10 MS/s	10 MS/s	5 MS/s
Measuring three or four channels	25 MS/s	5 MS/s	12.5 MS/s	5 MS/s	5 MS/s	2.5 MS/s
16 bit						
Measuring one channel	100 MS/s	20 MS/s	50 MS/s	20 MS/s	20 MS/s	10 MS/s
Measuring two channels	50 MS/s	10 MS/s	25 MS/s	10 MS/s	10 MS/s	5 MS/s
Measuring three or four channels	25 MS/s	5 MS/s	12.5 MS/s	5 MS/s	5 MS/s	2.5 MS/s
16 bit						
Measuring one channel	6.25 MS/s	3.125 MS/s	3.125 MS/s	3.125 MS/s	1.25 MS/s	625 kS/s
Measuring two channels					625 kS/s	312.5 kS/s
Measuring three or four channels						
Sampling source	TCXO					
Internal	Accuracy					
Accuracy	±0.0001 %					
Stability	±1 ppm over 0 °C to 55 °C					
Time base aging	±1 ppm per year					
External	LVDS, on auxiliary connectors					
Input range	10 MHz, 16.369 MHz					
Memory	Standard model					
	XM option					
8 bit						
Measuring one channel	1 MS / channel		256 MS / channel			
Measuring two channels	512 KS / channel		128 MS / channel			
Measuring three or four channels	256 KS / channel		64 MS / channel			
12, 14, 16 bit						
Measuring one channel	512 KS / channel		128 MS / channel			
Measuring two channels	256 KS / channel		64 MS / channel			
Measuring three or four channels	128 KS / channel		32 MS / channel			
Isolated male BNC inputs						
CH1, CH2, CH3, CH4						
Type	Differential inputs					
Resolution	8, 12, 14, 16 bit user selectable					
DC Accuracy	0.25 % (0.1 % typical) of full scale ± 1 LSB at 20 to 25 °C To achieve rated accuracy, allow the instrument to settle for 20 minutes. When subjected to extreme temperatures, allow additional time for internal temperatures to stabilize.					
Ranges (full scale)	±200 mV, ±400 mV, ±800 mV, ±2 V, ±4 V, ±8 V, ±20 V, ±40 V and ±80 V					
Coupling	AC/DC					
Impedance	2 MΩ / 12 pF ± 1 % 1 MΩ / 20 pF ± 1 % when SafeGround enabled					
Maximum input voltage	200 V (DC + AC peak < 10 kHz)					
Maximum common mode voltage	200 mV to 800 mV ranges		2 V to 8 V ranges		20 V to 80 V ranges	
	2 V		20 V		200 V	
Common Mode Rejection Ratio	-47 dB					
	HS6 DIFF-1000	HS6 DIFF-500	HS6 DIFF-200	HS6 DIFF-100	HS6 DIFF-50	
Bandwidth (-3dB) at 75 % of full scale input	250 MHz	250 MHz	250 MHz	100 MHz	100 MHz	
AC coupling cut off frequency (-3dB)	±1.5 Hz		±1.5 Hz		±1.5 Hz	
Bandwidth limit, selectable per channel	Off (250 MHz) 150 MHz 100 MHz 50 MHz	Off (250 MHz) 150 MHz 100 MHz 50 MHz	Off (250 MHz) 150 MHz 100 MHz 50 MHz	Off (100 MHz) 75 MHz 50 MHz 25 MHz	Off (100 MHz) 75 MHz 50 MHz 25 MHz	
SureConnect						
Maximum voltage on connection	Optionally available (option S) 200 V (DC + AC peak < 10 kHz)					
Resistance measurement						
Resistance measurement	Optionally available (option S)					
Ranges	100 Ohm to 2 MOhm full scale					
Accuracy	1 %					
Response time (to 95 %)	<10 μs					
SafeGround						
Maximum voltage on connection	Optionally available (option G) 200 V (DC + AC peak < 10 kHz)					
Maximum ground current	500 mA					
Response time	< 100 ns					

1. On some computers, the highest streaming rates may not be available, due to computer restrictions.

Trigger	
System	Digital, 2 levels
Source	CH1, CH2, CH3, CH4, digital external, OR
Trigger modes	Rising/falling/any edge, inside/outside window, enter/exit window, pulse width, runt pulse
Level adjustment	0 to 100 % of full scale
Hysteresis adjustment	0 to 100 % of full scale
Resolution	0.024 % (12 bits)/0.006 % (14/16 bits)
Pre trigger	0 to selected record length, 1 sample resolution
Post trigger	0 to selected record length, 1 sample resolution
Trigger hold-off	0 to 63 MSamples, 1 sample resolution
Trigger delay	0 to 16 GSamples, 1 sample resolution
Digital external trigger	
Input	Extension connector pins 1, 2
Range	0 to 2.5 V (TTL)
Coupling	DC
Jitter	≤ 1 sample

Multi instrument synchronization	
Maximum number of instruments	Limited by number available USB ports
Synchronization accuracy	0 ppm
CMI interface	2x, CMI 1, CMI 2
Required coupling cable	TP-C50H
Maximum coupling cable length	50 cm

Probe calibration	
Output	Extension connector pins 3 (signal) and 6 (ground)
Signal	Square wave
Level	-1 V to 1 V
Frequency	1 kHz

I/O connectors	
----------------	--

Front

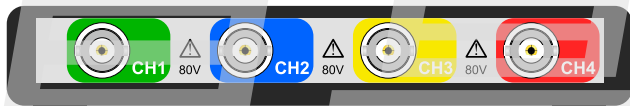

CH1, CH2, CH3, CH4	Isolated male BNC
Extra ground	2 mm gold plated banana socket next to Ch1, only with option E EMI

Rear

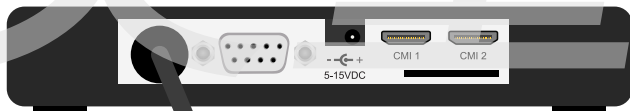

USB	Fixed cable with USB type A plug, 1.8 m
Extension connector	D-sub 9 pins female
Power	3.5 mm power socket
CMI connectors 1 to 2	HDMI type C socket

Physical	
Height	25 mm / 1.0"
Length	170 mm / 6.7"
Width	140 mm / 5.2"
Weight	500 g / 17.6 ounce
USB cord length	1.8 m / 70"

Interface	
Interface	USB 3.0 SuperSpeed (5 Gbit/s)

System requirements	
PC I/O connection	USB 2.0 USB 3.0 or USB 3.1
Operating System	Windows 7/8/10, 32 and 64 bits Linux (SDK only)

Environmental conditions	
Operating	
Ambient temperature	20 to 25 °C (10 to 40 °C without specifications)
Relative humidity	5 to 90 % non condensing
Storage	
Ambient temperature	-20 to 70 °C
Relative humidity	5 to 95 % non condensing

Certifications and Compliances	
CE mark compliance	Yes
RoHS	Yes
EN 55011:2009/A1:2010	Yes
EN 55022:2006/A1:2007	Yes
EN 61000-6-1:2007	Yes
EN 61000-6-3:2007	Yes

Power	
Power	From USB or external input
Consumption	5 Vdc, 1300 mA max
External power	From second USB port or power adapter

Power adapter	
Input	TP-UE15WCP1-055200SPA 110 to 240 Vac, 50 to 60 Hz 0.85 A Max., 50 VA to 80 VA
Output	5.5 Vdc, 2.0 A
Dimension	
Height	30 mm / 1.2"
Width	45 mm / 1.8"
Length	75 mm / 3"
Replaceable mains plugs for	EU, US, AU, UK
Order number	TP-UE15WCP1-055200SPA



Measure lead	
Connectors	
Instrument side	Isolated female BNC connector
Test point side	Red and black 4 mm shrouded banana jacks
Bandwidth	4 MHz
Safety	CAT III, 1000 V, double isolated
Dimensions	
Total length	2000 mm
Length to split	800 mm
Length individual ends	1200 mm
Weight	100 g
Color	Black
Certifications and compliances	
CE conformity	Yes
RoHS	Yes
Accessories	
Color coding rings	5 x 3 rings, various colors
Order number	TP-C812B



Differential attenuators	
Attenuation settings	TP-DA10 X10 differential
Bandwidth	25 MHz
Maximum input voltage	300 V (DC + peak AC)
Input impedance	10 MΩ / 15 pF
Input connector	Female BNC
Output connector	Male BNC
Dimensions	
Length	79 mm
Diameter	19 mm
Weight	30 g
Order number	TP-DA10-HS6-DIFF



D-sub to BNC adapter	
Connectors	
Instrument side	9 pin D-Sub male
Probe side	Female BNC
Dimensions	
Length	300 mm
Weight	30 g
Order number	TP-BNC-09



Handscope HS6 DIFF, the USB 3.0 oscilloscope packed with technology

Accessories included	
Instrument	Handscope HS6 DIFF : HS6-DIFF-xxx-xx (see below)
Measure leads	4 x TP-C812B Isolated female BNC to banana differential measure leads
Differential attenuators	4 x TP-DA10 differential attenuators 1:10
Alligator clips large	8 x TP-AC80I Alligator Clips, Green, Blue, Yellow, Red and 4 x Black
Alligator clips medium	8 x TP-AC10I Alligator Clips, Green, Blue, Yellow, Red and 4 x Black
Alligator clips small	8 x TP-AC5 Alligator Clips, Green, Blue, Yellow, Red and 4 x Black
Accessories	Power adapter : TP-UE15WCP1-055200SPA USB power cable : TP-USB-PWR-P3.5 D-sub to BNC adapter : TP-BNC-09, for calibrating the HP-3250I probe (only with option G) EMI probe set TP-EMI-HS6, only with option E
Software	For Windows 7/8/10
Drivers	For Windows 7/8/10
Manual	Instrument manual and software user's manual
Carry case	1 x TP-BB394 Carry case



Optional accessories	must be ordered separately	
Optional accessories	Order code	
Probe	HP-3250I	Probe 1:1 / 1:10. The HP-3250I must be ordered separately, and can only used with option G SafeGround .
Measure lead	TP-BNCI-100	BNC to banana single ended measure leads. The TP-BNCI-100 must be ordered separately, and can only used with option G SafeGround .
Back probes	TP-BP85-Set	Set of 8 back probes, green, blue, yellow, red and 4 x black. The TP-BP85-SET must be ordered separately.
Coupling cable	TP-C50H	Coupling cable to couple two Handscope HS6 DIFFs. The TP-C50H must be ordered separately.

Warranty	
Warranty	Three year standard, five years optional, covering all parts and labor, excluding probes

Customer service
 The Handscope HS6 DIFF is designed, manufactured and tested to provide high reliability. In the unlikely event you experience difficulties, the Handscope HS6 DIFF is fully warranted for three years. This warranty includes:

- No charge for return shipping
- Long-term 7-year support
- Upgrade to the latest software at no charge

Ordering information	
Handscope HS6 DIFF Model	Order code
1 GS/s, 1 MS, 3 year warranty	HS6-DIFF-1000
500 MS/s, 1 MS, 3 year warranty	HS6-DIFF-500
200 MS/s, 1 MS, 3 year warranty	HS6-DIFF-200
100 MS/s, 1 MS, 3 year warranty	HS6-DIFF-100
50 MS/s, 1 MS, 3 year warranty	HS6-DIFF-50

Available options for the Handscope HS6 DIFF are:

- **XM**: With the extended memory option, 256 MSamples memory is available. Add **XM** to the order code.
- **E**: With the EMI option, the Handscope HS6 DIFF can be used as EMI pre compliance tester. The option includes the TP-EMI-HS6 probe set. The EMI option is only available on a Handscope HS6 DIFF-1000 and requires options XM and G to be installed as well. Add **E** to the order code.
- **S**: With the **SureConnect** option, connection test and resistance measurement are available on all channels. Add **S** to the order code.
- **G**: With the **SafeGround** option, each input can be switched to single ended, including **SafeGround** ground current protection. Add **G** to the order code.
- **W5**: With the extended warranty option, warranty is five years on parts and labor. Add **-W5** to the order code.

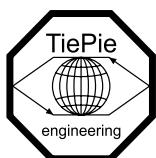

TiePie engineering
 Koperslagersstraat 37
 8601 WL Sneek
 The Netherlands

Tel.: +31 515 415 416
 Fax: +31 515 418 819
 E-mail: sales@tiepie.nl
www.tiepie.com/HS6D



This information is subject to change without notice. Copyright © 2019 TiePie engineering. All rights reserved. Revision 1.3, August, 2019.