

Lion

Tunable External Cavity Diode Laser
Littman/Metcalf Configuration

Scientific Lasers

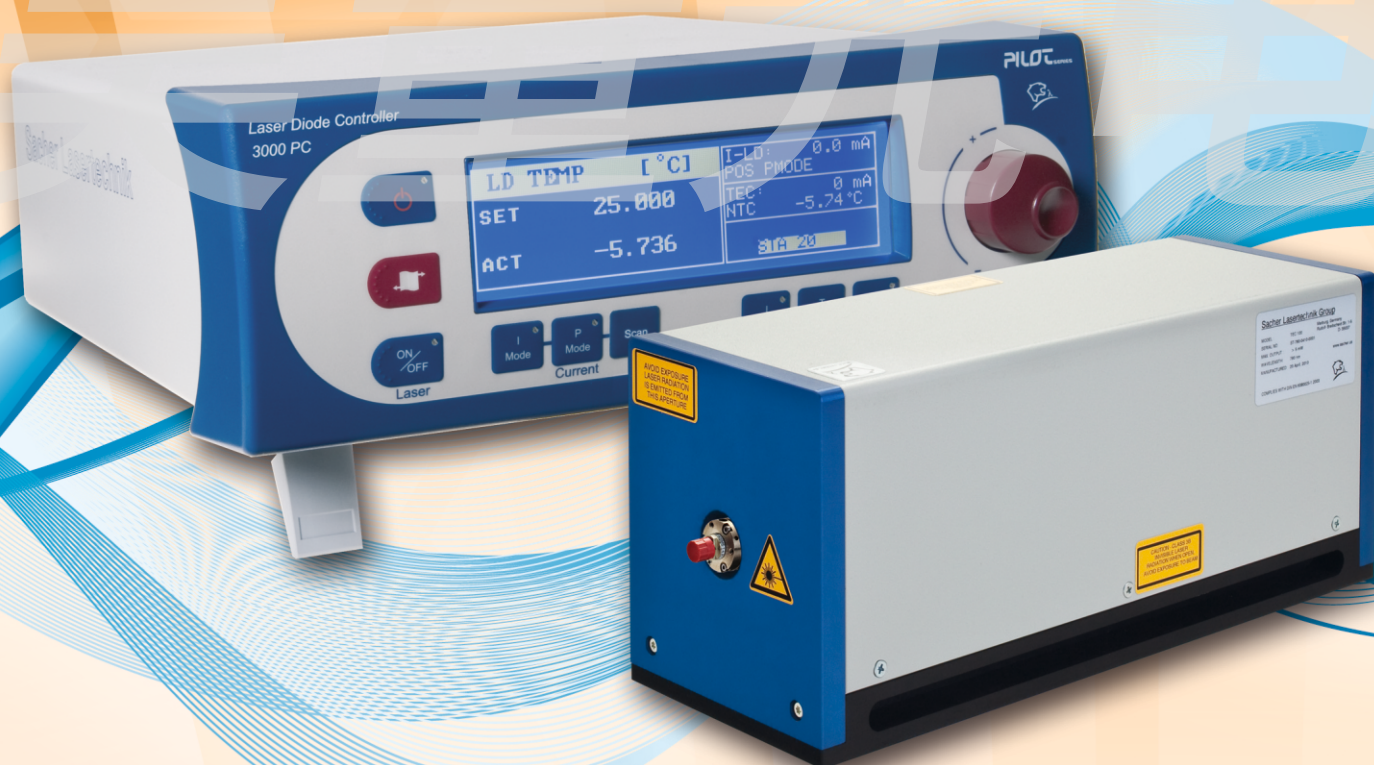



How does our Laser tune modehop-free ?

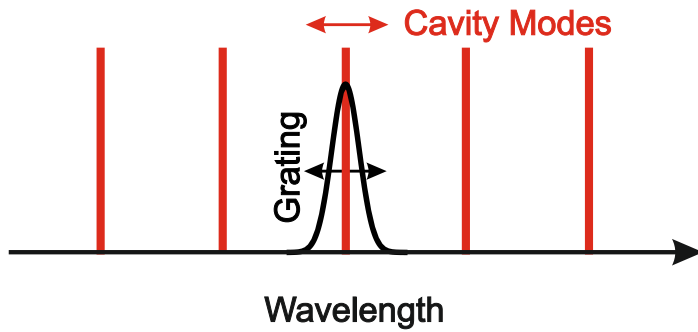

Lion

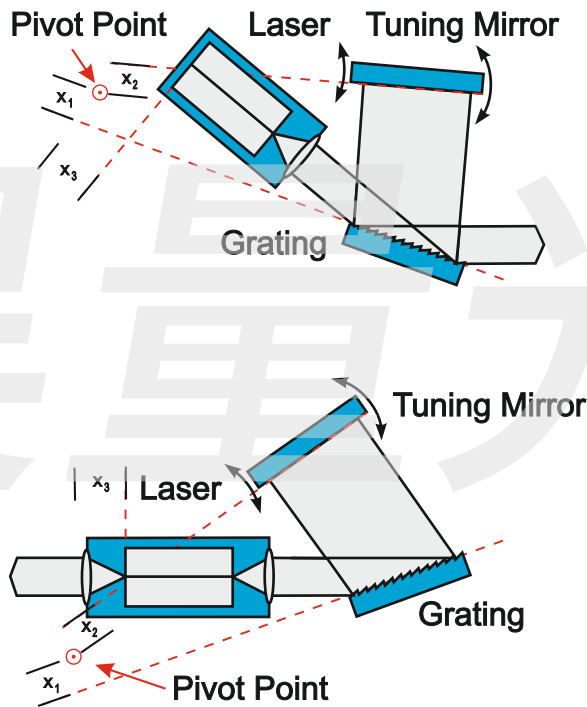

Physical Basics

The emission wavelength of a laser is defined by two features. The first condition is the cavity mode. The second condition is the amplification range of the gain medium. Since diode lasers have an extremely wide gain region, it is necessary to put a wavelength selective medium inside of the cavity like a grating. In order to tune such a laser modehop-free, it is required to synchronize the grating defined wavelength with the cavity defined wavelength [1].

Technical Solution

Sacher Lasertechnik has realized the synchronization between grating defined and cavity defined wavelength by only a simple rotation of the mirror. The adjustment of the pivot point is done during the wavelength scanning operation of our Littman/Metcalf laser system according to our patent no. 5,867,512. Due to this special method, we are able to ensure the best modehop free tuning behavior. An increase of the output power and the total performance of the Littman/Metcalf laser is achieved by using a high efficiency grating and outcoupling the light of the rear facet of the laser diode. With this approach, we are able to increase the output power to more than 100mW.

Dimensions

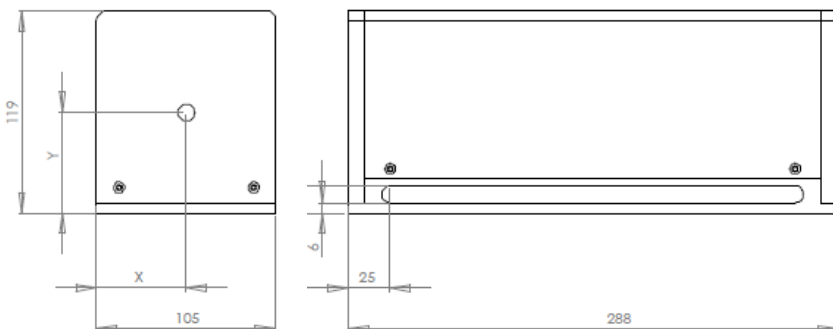

Technical Realization

The drawings on the left hand side show the technical realization and the dimensions of the TEC-500 and the TEC-520 external cavity diode laser systems. Due to using an alignment insensitive cavity design and a flex-mount concept, our Littman/Metcalf laser diode systems are excellent turn-key devices.

[1] M. G. Littman, H. J. Metcalf, Appl. Opt. 17, 2224, 1978

Key Features of our Littman/Metcalf Laser System

Side Mode Supression

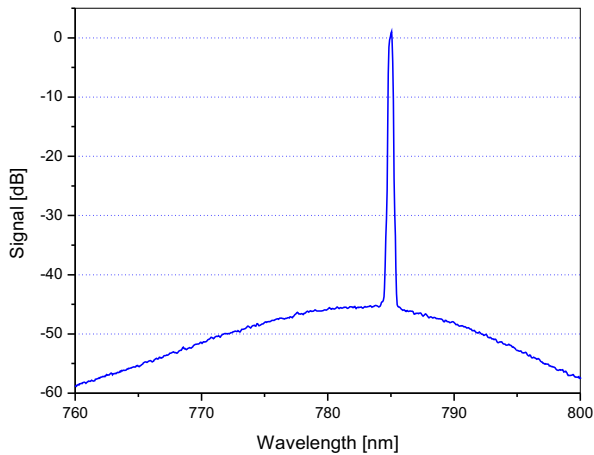

Example:
Power: > 100 mW at 780nm
 $M^2 < 1.3$ in both directions

Beam Quality

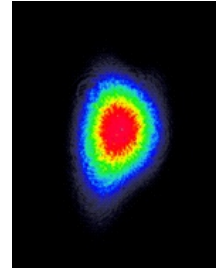

In-house manufacturing of AR-coatings, Patent 6,297,066

In house manufacturing of anti-reflection coatings for diode lasers guarantees the best performance for the complete laser system. for each type of application.

High passive stability

Realizing the pivot axis of the tuning grating and the cavity adjustment via flex-mounts ensures the highest passive stability of our Littrow laser system. As a result, we achieve a robust and highly stable external cavity diode laser system with excellent values for the long term laser linewidth.

Option: Single-mode fiber coupling

Due to the excellent mechanical stability of our Littrow laser system, we are able to perform high efficiency fiber coupling with coupling efficiencies between 60% and 85% into single-mode polarization maintaining optical fibers. Optical isolators and angled fiber connectors (FC/APC couplers) are available upon request.

Specification: Summary

Output Power	10 ... 150 mW (depending on wavelength)
Wavelength	635 nm ... 2450 nm with multiple laser heads
Wavelength Tuning	10 nm ... 250 nm (depends on wavelength)
Wavelength Tuning	10 nm ... 120 nm (depending on wavelength)
Piezo Tuning	30 GHz ... 120 GHz (depending on wavelength)
Linewidth	< 100 kHz @ 1ms (< 20 kHz @ 1ms typical)
Side Mode Supression	> 50 dB
Beam Quality M^2	< 1.3
Further Specification	Please contact us for further specification

Application Example

Carbon Di-Oxide Spectroscopy

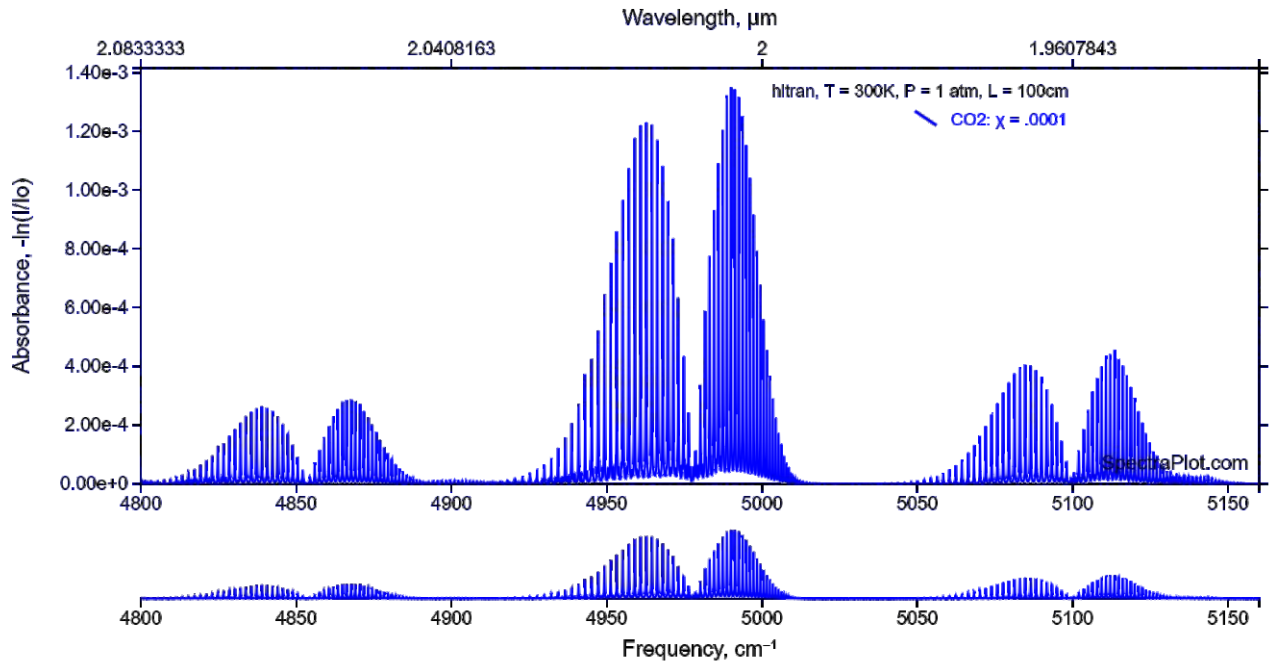

Matching Tunable Diode Laser (DC Motor Required)

Total Tuning Range

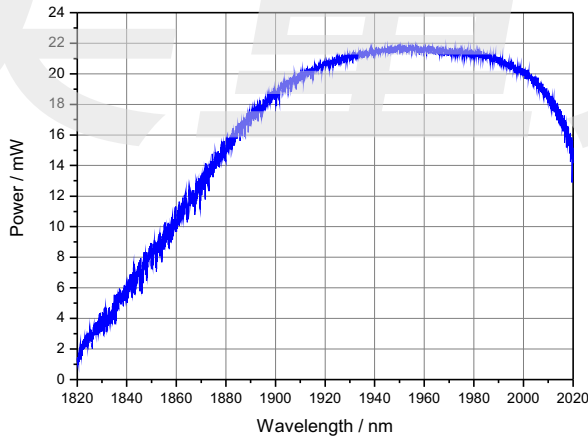

Smooth Mode-Hop Free Tuning

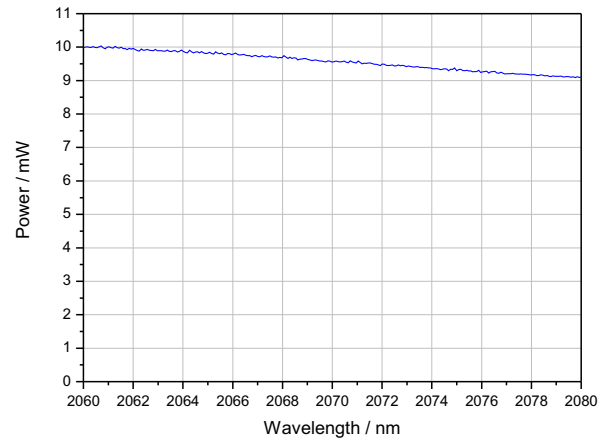
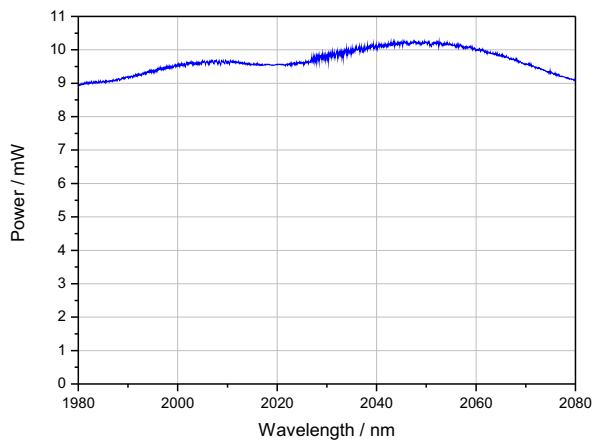
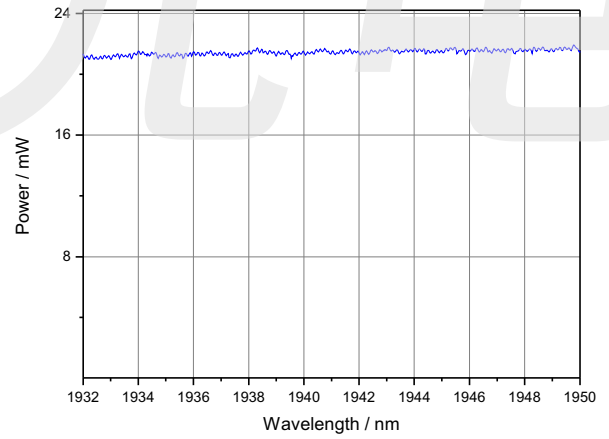

Application Example

Quantum Dot Spectroscopy

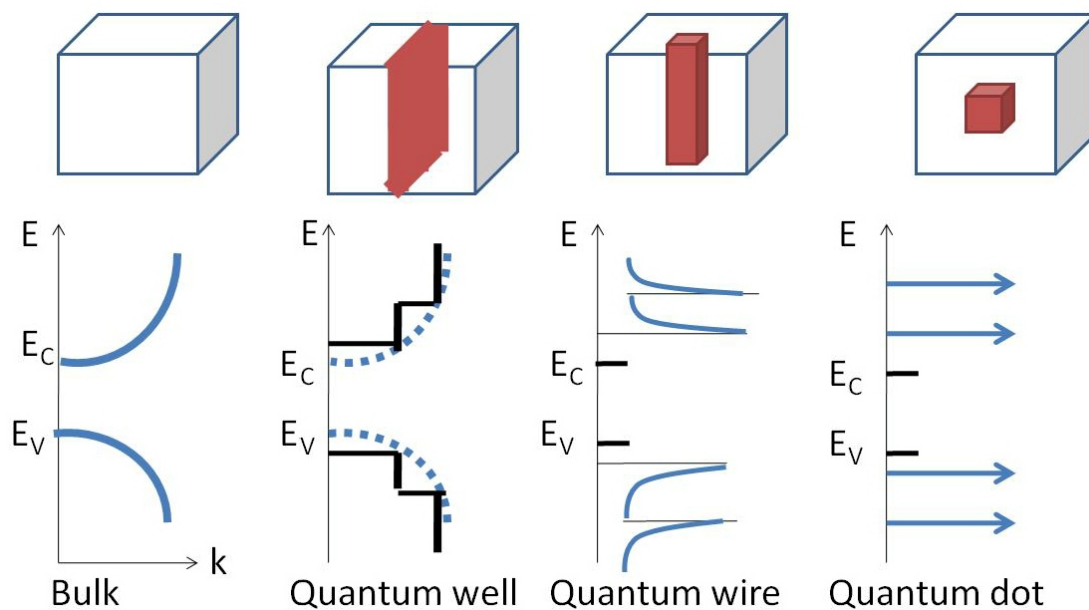

Matching Tunable Diode Laser (DC Motor Required)

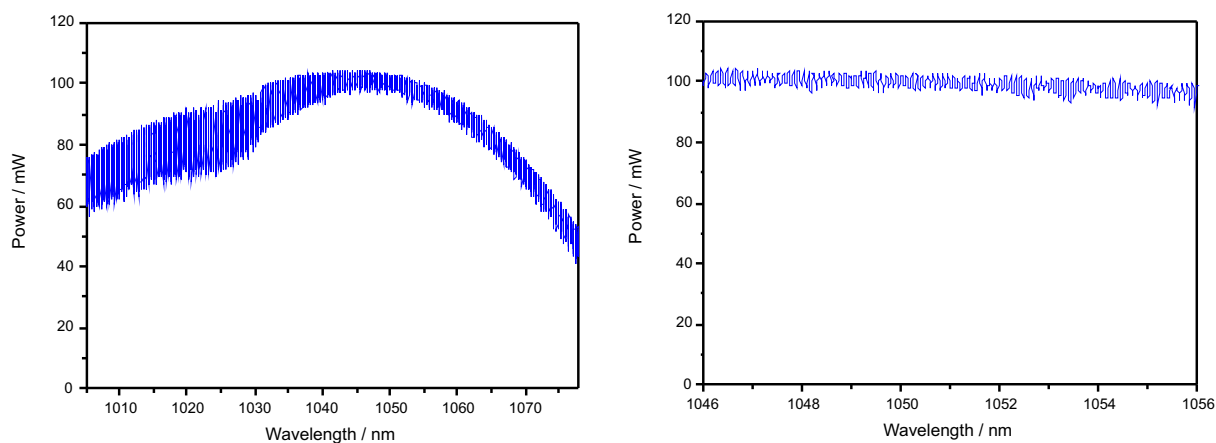
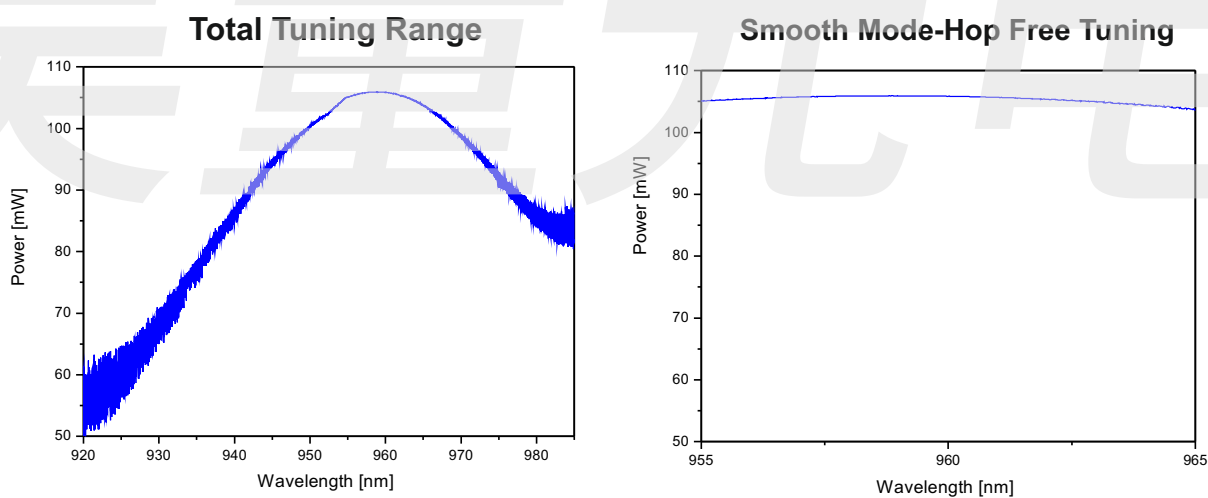

Application Example

Acetylene Spectroscopy

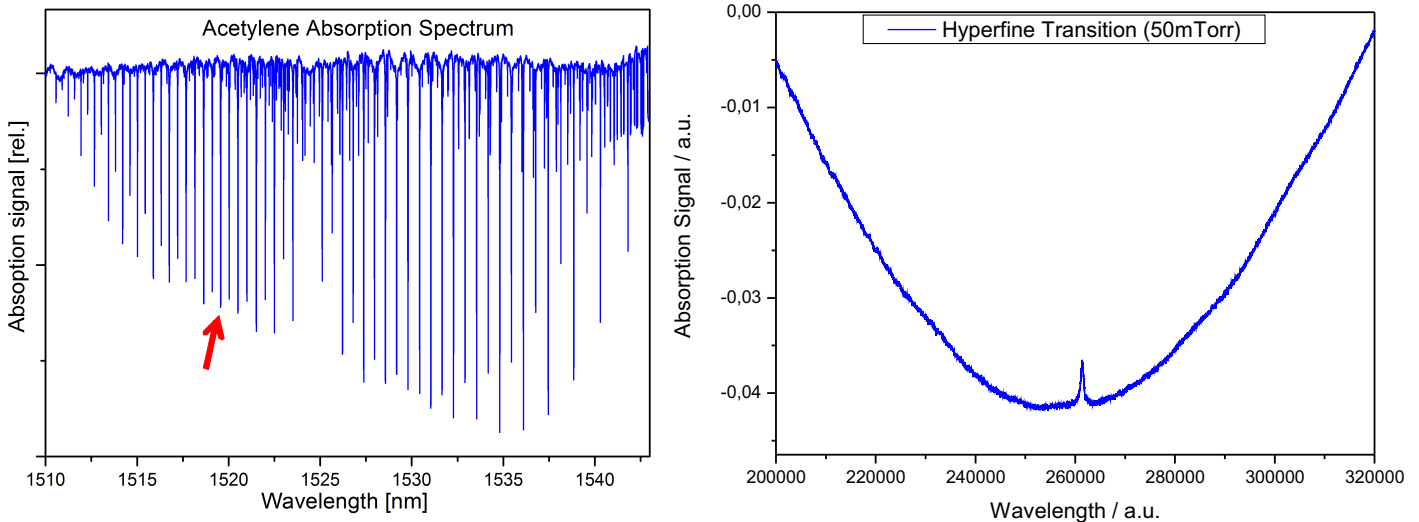

High resolution spectroscopy requires laser features like narrow linewidth, high passive stability, exact adjustable wavelength as well as an excellent modehop free fine tuning ability. The figure summarizes experimental data which have been determined with our Littman/Metcalf laser system. The lines shows an absorption signal of the Rotational Absorption Band of Acetylene in the 1530nm wavelength regime. More demanding is the Doppler-free detection of the Lamb dips (Demtröder Laser Spectroscopy, Springer 1998). The enlargement shows the Doppler-free measurement of the Lamb dip of R11 state at a gas pressure of 50mTorr.

About Sacher Lasertechnik

Company Profile

Sacher Lasertechnik is leading manufacturer of tunable external cavity diode lasers (ECDLs) with more than 25 years of experience. The product range includes anti-reflection coated diode lasers, ECDLs in Littrow and in Littman/Metcalf configuration as well as driver electronics for the LD and sophisticated measuring electronics. Please contact us with your measurement requirements. We would be proud to support you with our competence.

Please contact us

Sacher Lasertechnik
GmbH
Rudolf-Breitscheid Str. 1-5
D-35037 Marburg/Lahn
Germany
Tel.: +49 6421 305 - 0
Fax: +49 6421 305299

Sacher Lasertechnik
LLC
5765 Equador Way
Buena Park, CA90620
U. S. A.
Tel.: 1-800-352-3639
Fax: 1-714-670-7662

Email: contact@sacher-laser.com
Web: <http://www.sacher-laser.com>

