

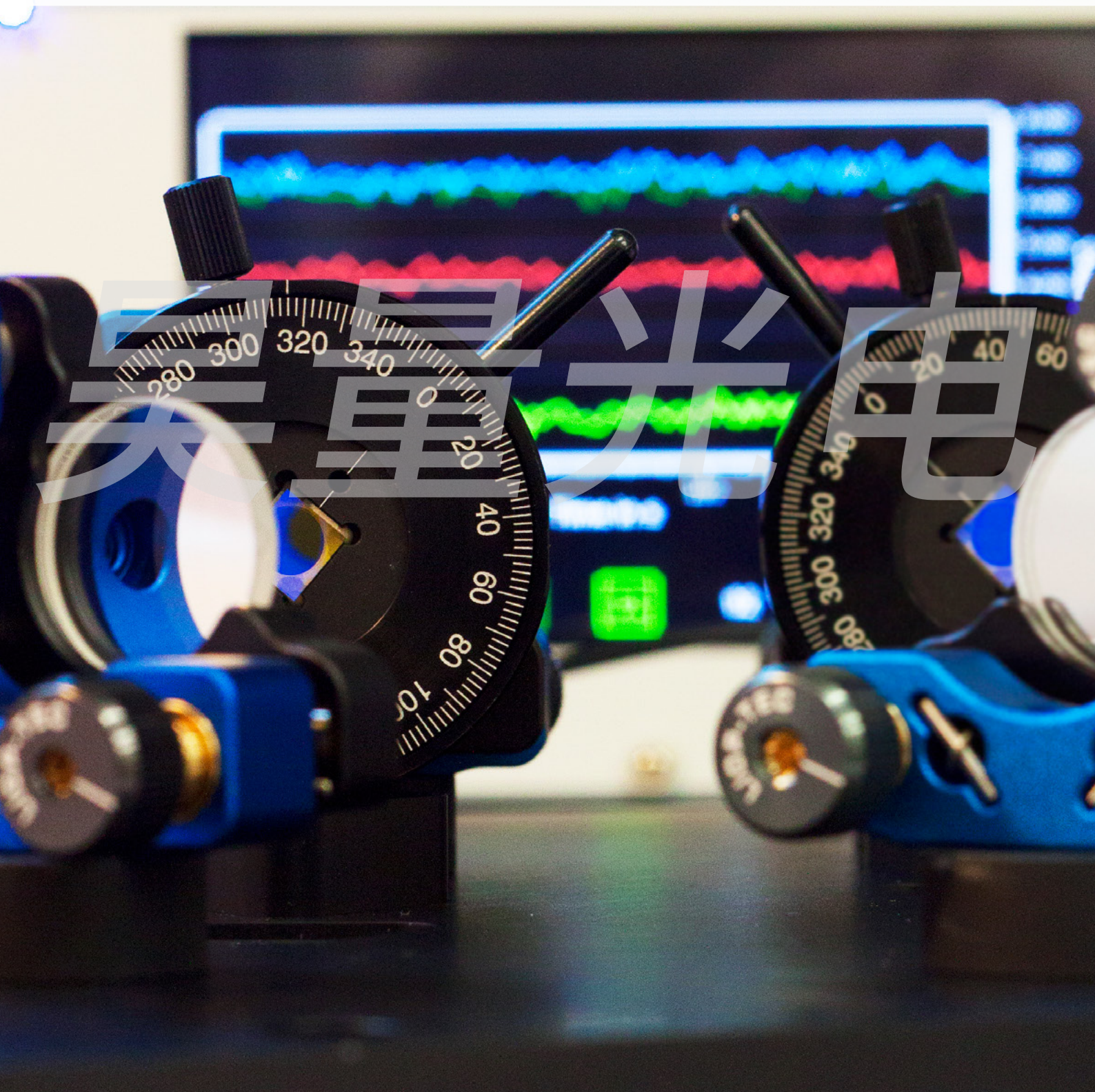

# quED - Entanglement Demonstrator

## A Science Kit for Quantum Physics



吴量光电

# Entanglement, Single Photons and Interference

Quantum theory is probably the most successful physical theory ever, and it is deeply rooted within the heart of modern physics. As such, it is only natural that the subject is part of every physicist's education. But the complex concepts and phenomena like superposition and entanglement sometimes contradict our everyday experience and are not easy to teach.

Ever since the dawn of quantum physics, it has intrigued and baffled physicists and philosophers alike. Even though the fundamental theory was developed early last century, many of the implications were understood only much later. For example, the famous Einstein-Podolsky-Rosen (EPR) paradox was published in 1935. Investigating some theoretically possible quantum states (later called entangled states), the EPR paper states that quantum theory could not be complete while still satisfying the notions of realism and locality. These notions were believed (or wished) to be unshakably true, so EPR believed quantum theory to be incomplete.

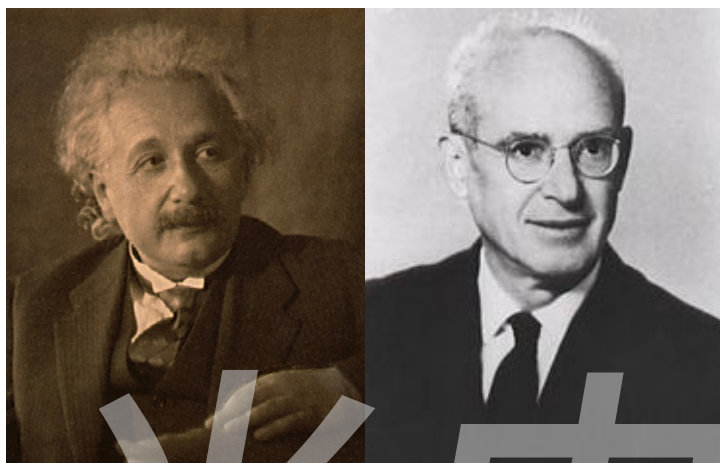

*Einstein and Rosen drafted in coordination with Podolsky their famous paper labeling effects originating from complementarity and entanglement the Einstein-Podolsky-Rosen paradox. – Wikipedia*

## Complete Theory

*“Every element of the physical reality must have a counterpart in the physical theory.”  
(EPR)*

For the next 30 years, this conflict was believed to be of purely philosophical interest with no theoretical or experimental means to differentiate between quantum theory and so called local hidden variable theories. In 1964 John Stewart Bell replied on the Einstein-Podolsky-Rosen Paradox, deriving an inequality making it possible to distinguish between all local realistic theories and quantum theory.

Interest began to rise again, and a few years later an experiment was proposed using a adapted inequality [Clauser, Horne, Shimony, Holt 1969]. But it would still be some time before the actual experiment could be performed in the early 80's by Aspect, Grangier and Roger, their setup filling the whole basement lab. The experimental data violated the inequality, refuting all local realistic theories and proving that quantum theory was right!



## Locality

*“... that the result of a measurement on one system be unaffected by operations on a distant system...” (Bell)*

*John Stewart Bell is the originator of Bell's theorem, important in quantum physics regarding hidden variable theories. – Wikipedia*

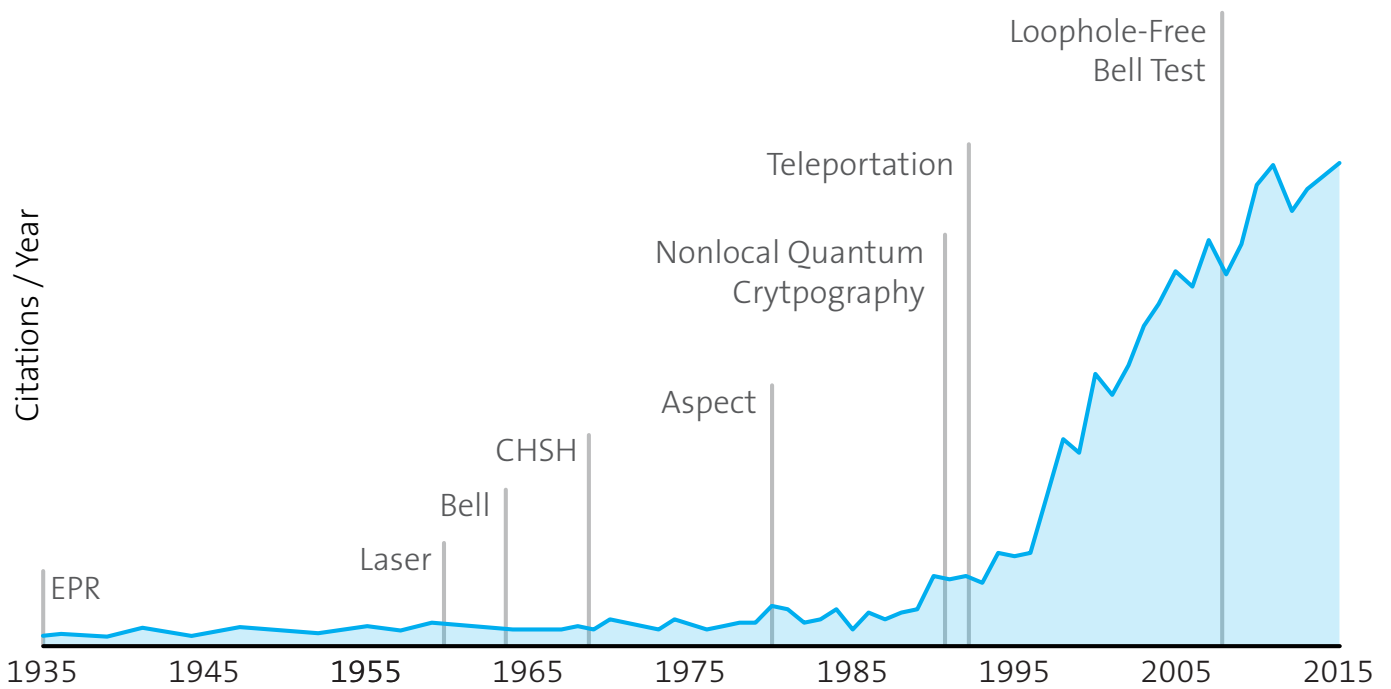

Citation statistics of the paper "Can Quantum-Mechanical Description of Physical Reality Be Considered Complete?" from 1935 by A. Einstein, B. Podolsky and N. Rosen.

With the ability to produce entangled states, different versions of Bell's inequality have been violated all over the world and entanglement has even become a resource to be used in elaborate schemes for secure communication [Ekert, 1991] and teleportation [Theory Bennett et al. 1993, Experiment Bouwmeester et al. 1997] of quantum states.

Nevertheless, the phenomenon of entanglement only sparsely finds place even in advanced university courses, and most of the times the lectures are not supported by experiments.

Qutools' Entanglement Demonstrator quED is designed to show the experimental violation of Bell's inequality, fits on any desk and can be set up in minutes. Additionally, it is more accurate and a lot more efficient than the apparatus of Aspect and his colleagues. In cooperation with its many add ons, the quED works as a source of indistinguishable photon pairs or of heralded single photons and can help to shed light on wave particle duality, quantum randomness, quantum cryptography protocols and many other fascinating aspects of quantum theory.

### Reality

*"If, without in any way disturbing a system, we can predict with certainty the value of a physical quantity, then there exists an element of physical reality corresponding to this physical quantity." (EPR)*



The quED frees the hands and brains of anyone trying to explain the complex phenomena of quantum physics. Because that's already hard enough.

# quED - A Science Kit for Quantum Physics

The Entanglement Demonstrator is designed for educational purposes. This easy-to-use system frees hands and brains to explain the complex phenomena of quantum mechanics.

The quED design combines recent achievements of quantum optics technology into an easy-to-use system for academic, research and applied purposes with precise accuracy. Advanced models for scientific purposes are available as well, with a high performance meeting the requirements of state-of-the-art physics experiments.

quED's Entanglement Demonstrator is designed with educators in mind. It's the easiest and most reliable way to explain the complex phenomena of quantum mechanics by generating and analyzing polarization-entangled photon pairs.

## Key Features

- Hands-on study of quantum entanglement
- Complete system, user-friendly operation
- High performance: Entanglement verification in a few seconds
- Educational material: Theory handbook, worksheets and lecture notes
- Add-ons to extend the number of experiments

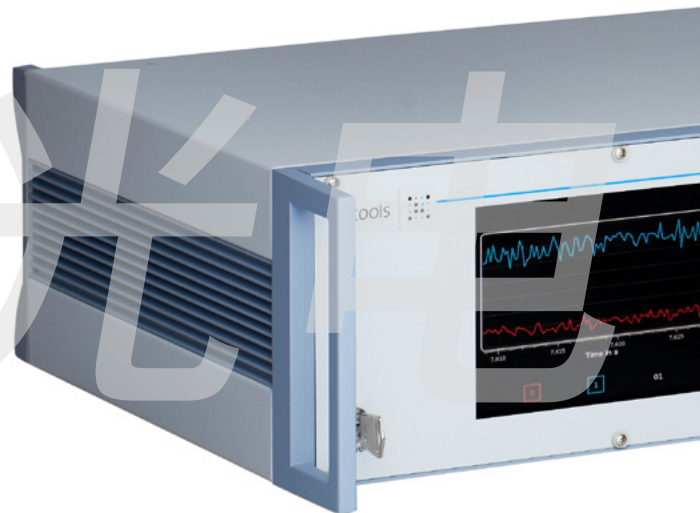

## Specific Applications

- Student lab course experiments
- Demonstration experiments in lectures
- Violate Bell's inequalities
- Correlation curves
- Heralded single photon source
- Quantum enhanced imaging

## Detection

- 2 temperature controlled avalanche photodiodes
- Extendable by 2 further APD detectors
- Singles & coincidence counting
- External TTL Read-Out



Manual polarizer for each arm of the entangled photon pair source.



Motorized rotating polarizer adjusted by the control unit with sub degree precision for the desired angular positions.

## Variants

- Manual rotating polarizer  
*Ideal for student lab courses, where the students are supposed to perform the measurements themselves.*
- Motorized rotating polarizer  
*Intended for demonstrations during lectures, when the result matters more than the process of measuring.*
- High rates version: pump laser power > 50 mW
- Tunable pulsed laser driver

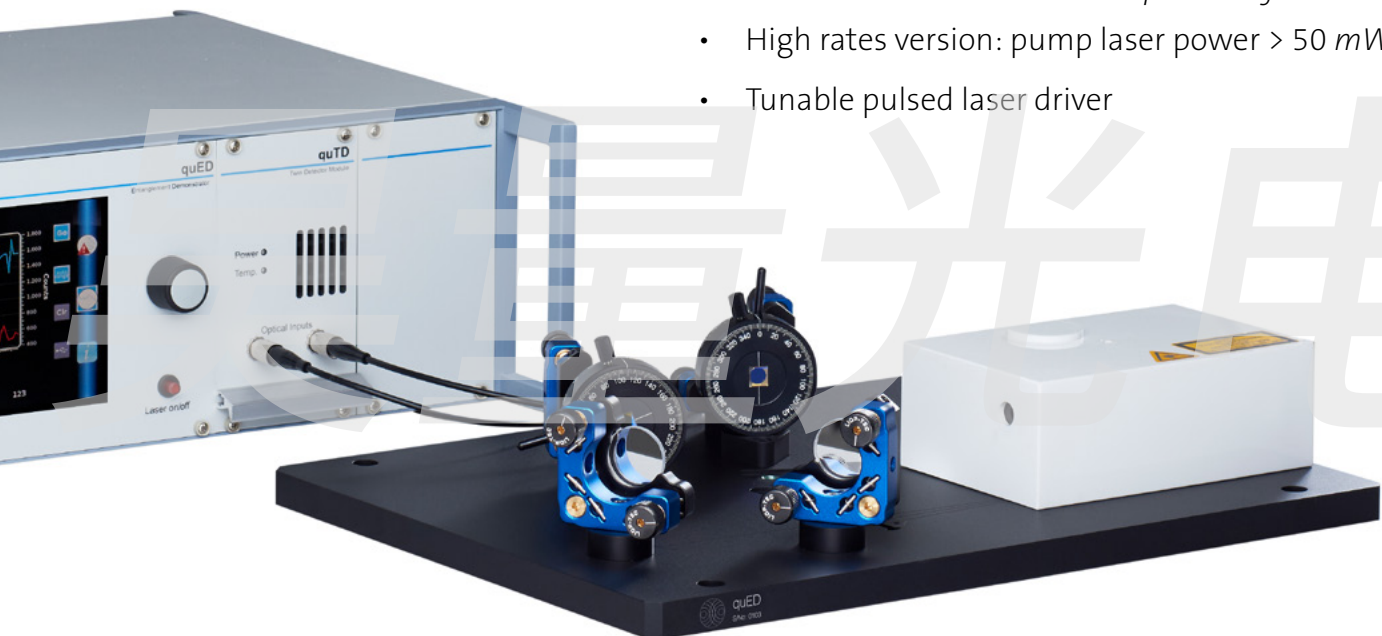

## Control and Readout Unit

- Touchscreen & rotary pushbutton
- Laser driver controller, APDs and motorized parts
- User-friendly software for data acquisition
- Individual experiment views
- Data export via USB and TCP
- Remote desktop



*The touch display controls the complete system: laser driver, APDs, experiments, analysis.*

# The Photon Source and Sample Experiments

## The photon source of the quED: Spontaneous parametric down-conversion generates entangled photon pairs

The heart of the quED is made out of  $\beta$ -Barium-Borate (BBO), a special optical non-linear crystal. A high power UV diode laser at 405 nm wavelength, called the **pump laser**, is focused in this crystal. If the polarization of the pump beam and the axis of the BBO crystal are matched in a way enabling energy and momentum conservation, some of the pump photons are converted into two lower energy near infrared photons at 810 nm. These down converted photons then emerge at opposite sides of a so-called emission cone and form a photon pair.

Even though the conversion rate is low (only about 1 of 100.000.000.000 pump photons is converted), these photon pairs are quite useful, since whenever you observe a photon on one side, you know that there must be one on the other side, too! Therefore, you call them **heralded single photons**, and they can then be used in further experiments.

It becomes even more interesting if you add another BBO crystal with the optical axis perpendicular to the first one, condition the pump laser polarization by inserting a half wave plate (HWP) and compensate some temporal shifts and dispersion effects by two Ytterbium Vanadate (YVO) crystals: The photon pairs from the two crystals are **coherently overlapped**, so one cannot distinguish between pairs originated from the first or second crystal.

This is the condition for creating **polarization entanglement** between the photons of one such pair. The quED unites this pre-aligned SPDC source, single photon detectors and a control and readout unit.

Inside the quED source, the half wave plate can also be put into a passive parking position, such that only one of the BBO crystals fulfills the phase matching conditions and therefore generates non-entangled photon pairs.

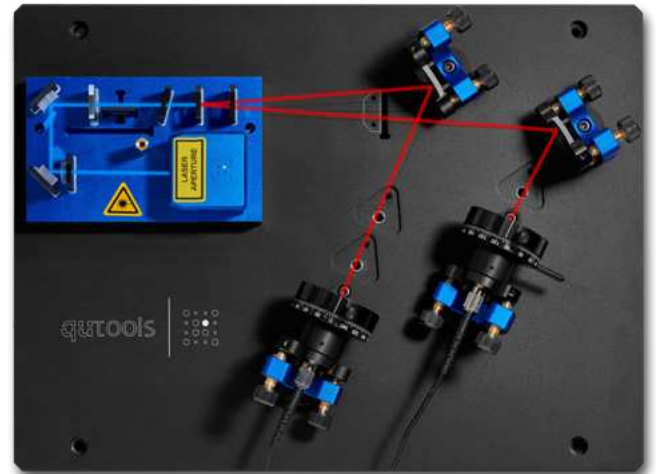

*Optical path within the photon source. Pump laser in blue and down-converted photon pairs in red after passing multiple non-linear crystals and finally coupling into the fibers leading to the read-out unit and the avalanche photodiodes.*

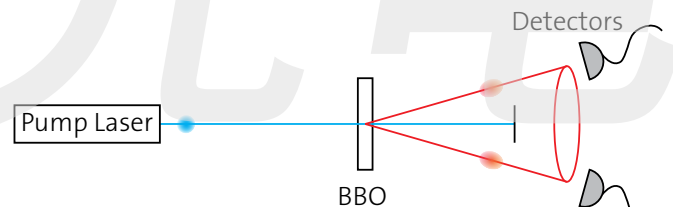

*The pump laser focuses light into one non-linear crystal, the BBO. The spontaneous parametric down-conversion generates two photons according to conservation of energy and momentum.*

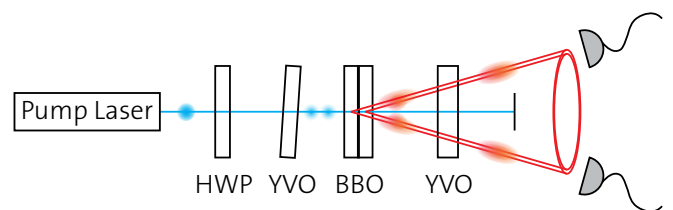

*A second, perpendicular non-linear crystal allows the conversion for the perpendicular polarization. The two optically non-linear YVO crystals compensate the temporal shifts and dispersion effects due to different polarizations.*

## Summary of all prepared experiments with the Entanglement Demonstrator quED and its add-ons

Since the quED can be used as a source of heralded single photons, non-entangled photon pairs or even polarization entangled pairs and the control unit allows up to 4 detectors, a multitude of quantum optical experiments is possible.

### Single Photon Experiments

#### with Interference

Wave Nature of Photons: Single Photon Michelson Interferometer	<i>quED-MI</i>
Quantum Eraser	<i>quED-MI</i>
Wave-Particle Dualism: Interference & Indifisibility	<i>quED-MI &amp; quED-HBT</i>
Double Michelson Interferometer	<i>quED-MI 2x</i>
Visible (White) Light Interference (Observable by Eye)	<i>quED-MI &amp; other</i>
Measurement of Central Wavelength of Single Photons	<i>quED-MI</i>
Measurement of Coherence Length of Single Photons	<i>quED-MI</i>
Interaction-Free Measurement (Bomb Test)	<i>quED-MI &amp; quED-QKD &amp; other</i>

#### without Interference

Particle Nature of Photons	<i>quED-HBT</i>
Second order correlation function	<i>quED-HBT</i>
Quantum Cryptography / QKD: BB84 Protocol	<i>quED-QKD</i>
Tomographic Single Photon State Reconstruction	<i>other</i>
Quantum Zeno Effect	<i>other</i>
Quantum Random Number Generation	<i>quED-HBT</i>
Photon number statistics and the second order correlation function	<i>quED-HBT</i>

### Photon Pair Experiments

#### with Polarization Entanglement

Violation of Bell's Inequality (CHSH)	
"Non-Classical" Polarization Correlations	
Tomographic State Reconstruction of an Entangled Photon State	<i>other</i>
Quantum Cryptography / QKD: BBM Protocol	<i>other</i>
Quantum Cryptography: Ekert Protocol	<i>other</i>

#### without Polarization Entanglement

Hong-Ou-Mandel 2-Photon Interference	<i>quED -HOM</i>
Hong-Ou-Mandel Interference + Hanbury Brown & Twiss	<i>quED-HBT &amp; quED-HOM</i>
Franson Interference	<i>quED-MI 2x</i>

#### Add-on Indication

<i>Michelson Interferometer</i>	<i>quED-MI</i>
<i>Hong-Ou-Mandel Effect</i>	<i>quED-HOM</i>
<i>Hanbury Brown Twiss Setup</i>	<i>quED-HBT</i>
<i>Quantum Key Distribution</i>	<i>quED-QKD</i>

# Add-Ons to extend the quED

The functionality of the quED system can easily be extended by various optical add-ons.

## quED-MI - Michelson Interferometer

Interference is generally considered to be a wave phenomenon. Curiously it also works with single quantum objects. Use the quED-MI Michelson Interferometer and the quED to show this is the case.

### Variants

A linear translation stage moves a glass wedge into one arm to vary its optical path.

- Manual  
*Adjustment screws for micrometer steps.*
- Motorized  
*The control unit executes all steps of an experiment via a motor driver.*

### Feature

3 polarizers can be swung in and out of the interferometer at all exit surfaces of the beam splitter realizing a quantum eraser.

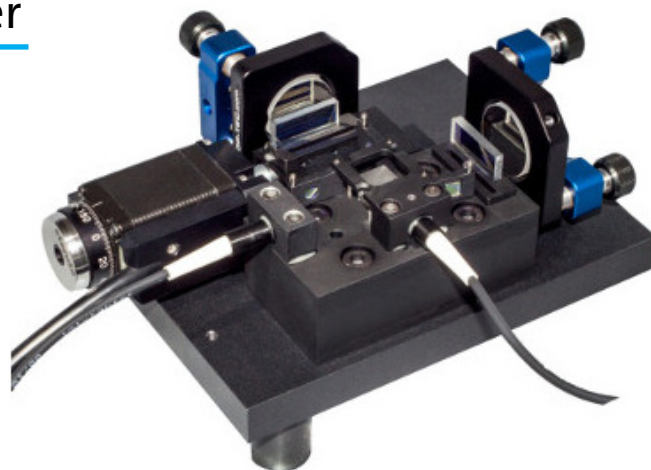

Constructive Interference

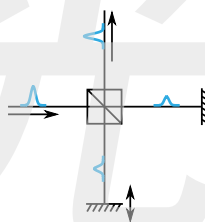

Destructive Interference

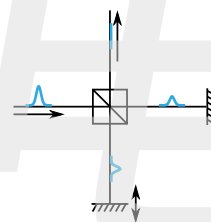

## quED-HOM - Hong-Ou-Mandel

When you have two indistinguishable photons and each of them hits one input of a beam splitter, they always exit the beam splitter together in one output port. This is a purely quantum interference effect with no classical analog.

### Variants

The linear translation stage to vary the optical distance in one arm can be:

- Manual
- Motorized

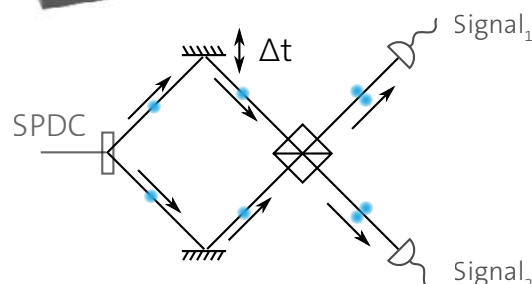



## quED-QKD - Quantum Key Distribution

One of the most popular industrial applications for quantum phenomena right now is quantum cryptography, or better, quantum key distribution. With the quED and this add-on, you can demonstrate realistically how a secure communication between two parties (Alice and Bob) is made possible by the BB84 protocol in a real environment and detect evesdropping.



### Variants

- Manual  
*The half-wave-plate and the polarizer have to be set manually, the results are also taken by hand.*
- Motorized  
*Random numbers can be used to automatically set the half-wave-plate and the polarizer.*

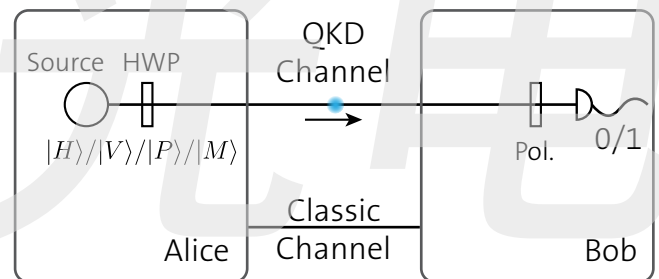

### Feature

The tunable pulsed laser driver yields additional benefits for all experiments and other add-ons.

## quED-HBT - Hanbury Brown Twiss

Photons, or more generally quantum objects, sometimes behave like particles. With the quED and this add-on you can show that individual photons cannot be split up.

You can also measure a second order correlation function  $g^{(2)}(0)$  to study photon statistics in only one arm of the quED or use the second arm as a trigger for the heralded case, explore a simple quantum random bit and number generator or use the quED-HBT in combination with the quED-MI to show wave and particle nature of photons in one experiment.



# Sample Experiments

## Polarization Entanglement – Violating Bell’s Inequality (CHSH) and proving that quantum theory is right!

The definition of an entangled state in quantum physics can be rather simple: It says two quantum objects cannot be described separately anymore, only together.

If one wants to show that a quantum system is entangled, usually a so-called Bell inequality is employed. In the case of polarization entangled photon pairs (as emitted from the quED), the so-called “CHSH” inequality is often chosen.

Classical (“local realistic”) theories predict that a certain value “S” has an upper bound of 2 (meaning  $S \leq 2$ ). When quantum theory is used to calculate the corresponding value, S can exceed a value of 2, the new bound is  $2\sqrt{2}$ .

Practically, this S value is determined by measuring the coincidence count rate at 16 different polarizer settings and adding and subtracting these values. So, we put one polarizer in each arm: The quCR software helps with the measurements and outputs the S value.

We said that any S value above 2 shows it is an entangled state. Here we measured  $S=2.7$ , so the state is well entangled.

What happens if we put in a non-entangled (= separable) state? We can produce such a state with the quED when we remove the wave plate in the pump beam. Switch off the pump laser, open the round lid of the white pump beam box, remove the wave plate from the beam, put the lid back on and switch on the laser.

The measured S value will be well below 2. What does this S value mean? Can we decide if this state is entangled or not? Can it be explained classically, by local-realistic theories, or by quantum theory?

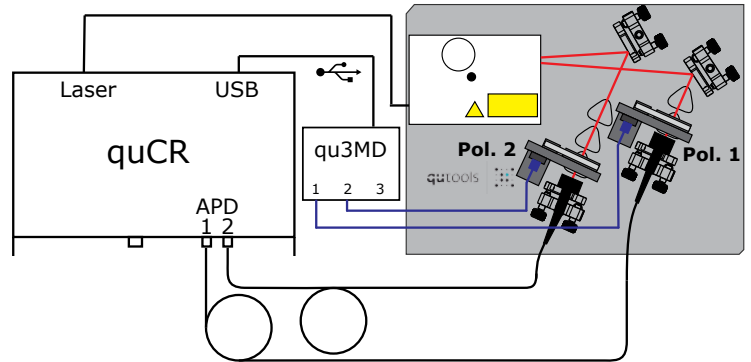

Entangled photon pair source with motorized polariser in each arm, connected to the control and read-out unit quCR via polarization-maintaining fibers.

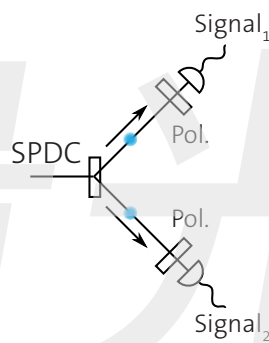

Both photons of one pair, originated in non-linear crystals by spontaneous parametric down-conversion, have to pass a polarizer before they can be registered by the avalanche photodiodes.

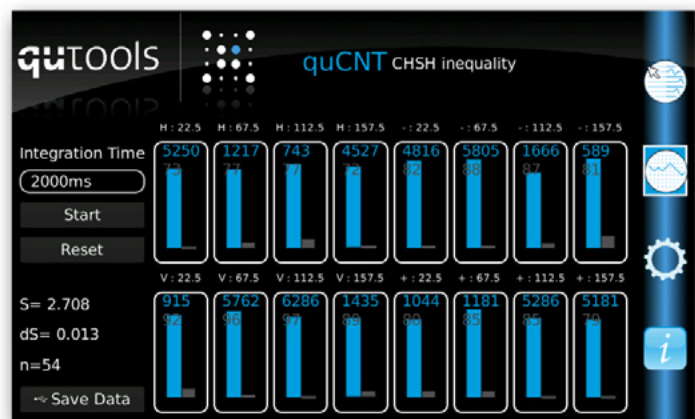

Counting coincidences between both avalanche photodiodes at a certain polarization and calculating the CHSH inequality. In this case, the inequality has been violated by  $S=2.708$ .



## The Franson Interference is of the most mind-boggling experiments you can do with the quED and its add-ons.

At first, we set up the two quED-MI, one in each arm of the quED. The wave plate in the pump beam can be removed, since we need no polarization entanglement.

Changing the optical path length in each interferometer will show the “standard” single photon interference effect when both arm lengths are nearly balanced, red in the screenshot below.

Now we change the optical path length difference in one of the interferometers to be far greater than the coherence length, i.e. the envelope of the single photon interference pattern, and scan the other one.

After we perform the same measurement again, the interference pattern again only appears around zero path length difference in the scanning interferometer. This is not so astonishing, since for the events in one arm it does not matter what happens in the other one.

When measuring coincidence counts, however, we see three distinct interference patterns. Besides the known central interference pattern, two more can be observed, symmetrically distributed around the first one.

Each is centered around the corresponding path length difference that is the same as the one present in the static interferometer, with the variable arm being the shorter or longer arm, respectively.

What does that mean? Is this another kind of entanglement (remember we did not use polarization entangled photons)? Is there even a Bell inequality to show that?

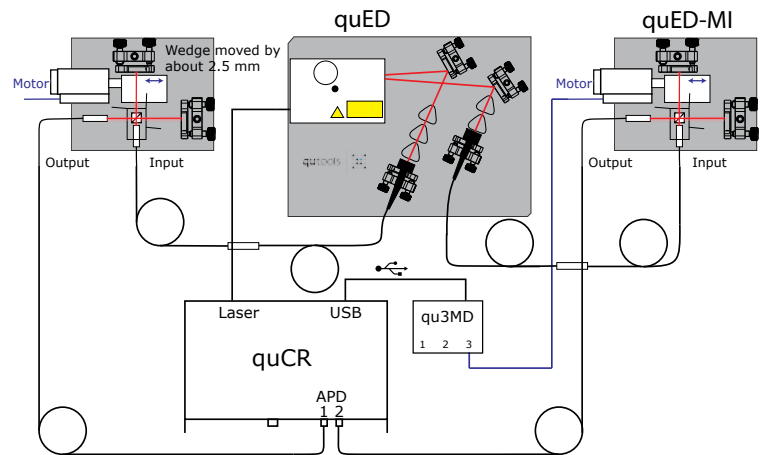

*Entangled photon source with two motorized Michelson add-ons in each arm, connected to the control and read-out unit quCR via polarization-maintaining fibers.*

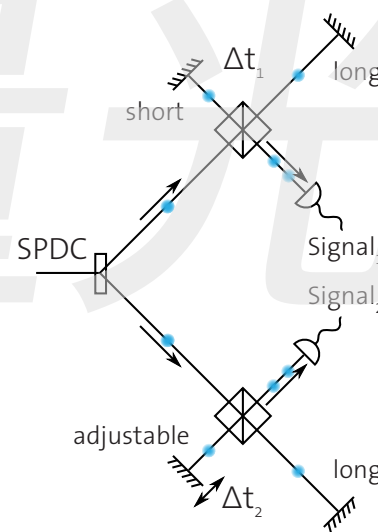

*The quED is used as a source of photon pairs, without using the wave plate. Each pair is sent into an unbalanced Michelson Interferometer, and in one of them the arm length difference can be modulated.*

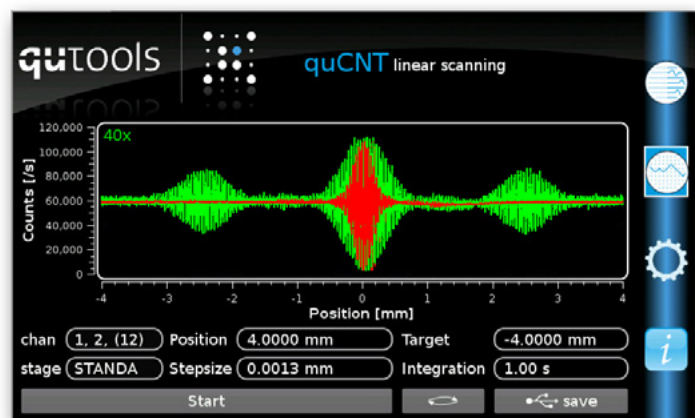

*The distinct interference patterns of coincidence counts (green) and singles (red) over displacement.*

# Further Products

## Precision measurement devices for research and industry and quantum physics science kits for education

### Quantum Physics in Teaching

Our **Quantenkoffer** is a plug and play quantum science kit for schools and universities with single and entangled photon pairs. Multiple tokens with different optical abilities give a huge variety of experiments.



The **quNV** is an educational setup for quantum sensing by a diamond magnetometer based on nitrogen-vacancy (NV) centers. Discover the world of quantum physics with spin manipulation or even single qubits!

### Time tagging for research and industry

**quTAG** and **quTAU** are precise time tagging devices with picosecond resolution. Some of its applications are Time Correlated Single Photon Counting (TCSPC), Lidar and characterization of single photon sources. Furthermore the time tagger are applied in time-resolved fluorescence microscopy like FLIM, FCS and FRET.

### Distance Measurement

Interferometric laser distance measurement with the **quDIS** provides up to sub-nanometer digital resolution.

This laser system measures even absolute distances with micrometer resolution and is expandable by multiple axis.



### qutools GmbH

Kistlerhofstraße 70, Geb. 88  
81379 München, Germany