

The DR-DG-40-MO is a driver module optimized for digital applications at 40 Gbps – 44 Gbps data rate. It exhibits an output voltage of 6.3 V<sub>pp</sub> and a broad bandwidth of 40 GHz.

The DR-DG-40-MO is housed in a compact package that integrates voltage regulators allowing for flexible biasing, while internal bias sequencing circuitry assures robust operation and single voltage power supply for maximum ease of use. It features two control inputs: one for gain control, the second one for crossing point adjustment. The RF connectors are V type, allowing easy and repeatable connections.

### FEATURES

- Output voltage 6.3 V<sub>pp</sub>
- Flat gain up to 40 GHz
- Single voltage power supply
- Gain and crossing point adjustment

### APPLICATIONS

- LiNbO<sub>3</sub> & InP modulators
- 40 Gbps - 44 Gbps NRZ / RZ
- SONET OC-768 / SDH-256
- Research & Development

### OPTIONS

- Heat-sink
- Analog version
- Low output voltage version for EAM

### RELATED EQUIPMENTS

- MX-LN-40, MXAN-LN-40 modulators
- MBC-DG Automatic Bias Controllers

The DR-DG-40-MO combines high performance and user friendliness, it is the ideal device to drive 40 Gbps modulators and to obtain widely opened optical eye diagrams with short jitter and high SNR.

### Performance Highlights

Parameter	Min	Typ	Max	Unit
Cut-off frequencies	50 k	-	40 G	Hz
Output Voltage	-	6.3	-	V <sub>pp</sub>
Gain	-	26	-	dB
Saturated Power	20	-	-	dBm
Added Jitter	-	0.75	-	ps
Rise / Fall Times	-	9	12	ps

Measurements for V<sub>bias</sub> = 8 V, V<sub>amp</sub> = 2.1 V, V<sub>xp</sub> = 1.7 V, I<sub>bias</sub> = 282 mA

### 40 Gbps Output Response

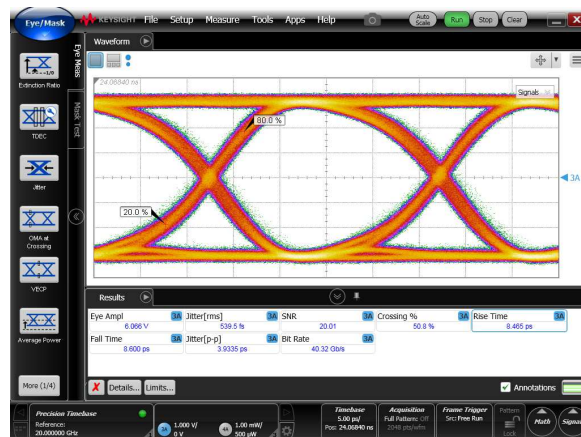

## DC Electrical Characteristics

Parameter	Symbol	Min	Typ	Max	Unit
Supply voltage (fixed)	$V_{bias}$	7	8	12	V
Current consumption	$I_{bias}$	-	300	350	mA
Gain control voltage	$V_{amp}$	0	1.5	2	V
Cross point control voltage	$V_{xp}$	0	0.8	2.5	V

## Electrical Characteristics

Parameter	Symbol	Condition	Min	Typ	Max	Unit
Lower frequency	$f_{3dB}^{lower}$	-3 dB point	-	-	50	kHz
Upper frequency	$f_{3dB}^{upper}$	-3 dB point	36	40	-	GHz
Gain	$S_{21}$	Small signal	-	26	-	dB
Gain ripple	-	< 40 GHz	-	±1.5	-	dB
Input return loss	$S_{11}$	50 MHz < f < 30 GHz	-	-10	-	dB
Output return loss	$S_{22}$	50 MHz < f < 30 GHz	-	-10	-	dB
Saturated power	$P_{sat}$	$V_{in} = 0.45 V_{pp}$	20	-	-	dBm
Output voltage	$V_{out}$	$V_{in} = 0.45 V_{pp}$	-	6.3	6.5	$V_{pp}$
Rise time / Fall time	$t_r / t_f$	20 % - 80 %	-	9	12	ps
Added jitter	$J_{RMS}$	$J_{RMS} = \sqrt{J_{RMS-total}^2 - J_{RMS-source}^2}$	-	0.75	-	ps
Power dissipation	P	$V_{out} = 6.3 V_{pp}$	-	2.4	-	W

Conditions:  $V_{in} = 0.65 V_{pp}$ ,  $T_{amb} = 25^\circ C$ , 50  $\Omega$  system

## Absolute Maximum Ratings

Stresses in excess of the absolute maximum ratings can cause permanent damage to the device. These are absolute stress ratings only. Functional operation of the device is not implied at these or any other conditions in excess of those given in the operational sections of the data sheet. Exposure to absolute maximum ratings for extended periods can adversely affect device reliability.

Parameter	Symbol	Min	Max	Unit
RF input voltage	$V_{in}$	-	1	$V_{pp}$
Supply Voltage	$V_{bias}$	0	12	V
DC current	$I_{bias}$	0	350	mA
Gain control voltage	$V_{amp}$	0	2	V
Cross point control voltage	$V_{xp}$	0	2.5	V
Power dissipation	$P_{diss}$	-	4.2	W
Temperature of operation	$T_{op}$	0	40	$^\circ C$
Storage temperature	$T_{st}$	-20	+70	$^\circ C$

**S<sub>21</sub> Parameter Curve**

Conditions:  $V_{bias} = 12\text{ V}$ ,  $V_{amp} = 1.5\text{ V}$ ,  $V_{xp} = 0.8\text{ V}$ ,  $I_{bias} = 300\text{ mA}$

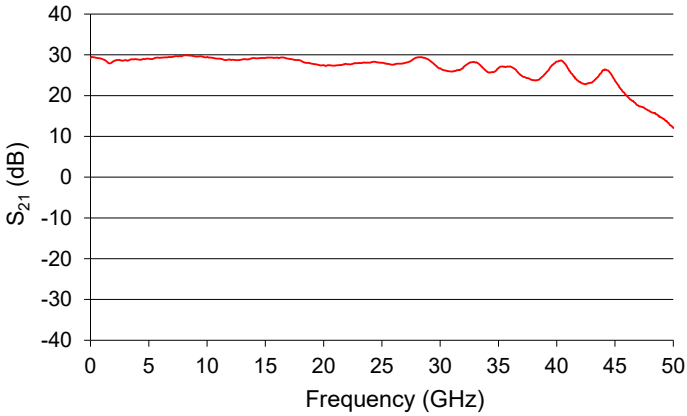

**Group Delay Parameter Curve**

Conditions:  $V_{bias} = 12\text{ V}$ ,  $V_{amp} = 1.5\text{ V}$ ,  $V_{xp} = 0.8\text{ V}$ ,  $I_{bias} = 300\text{ mA}$

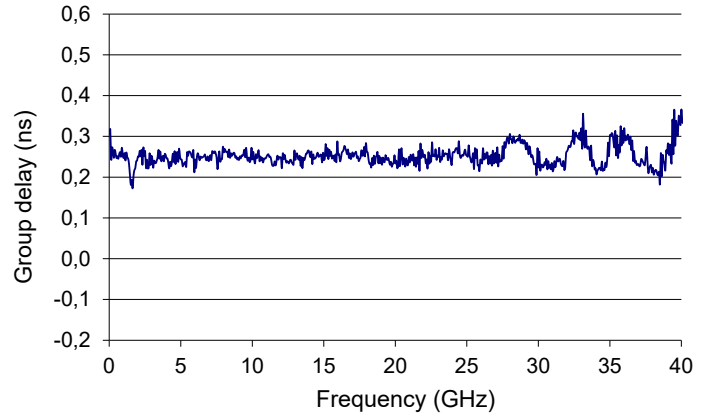

**S<sub>22</sub> Parameter Curve**

Conditions:  $V_{bias} = 12\text{ V}$ ,  $V_{amp} = 1.5\text{ V}$ ,  $V_{xp} = 0.8\text{ V}$ ,  $I_{bias} = 300\text{ mA}$

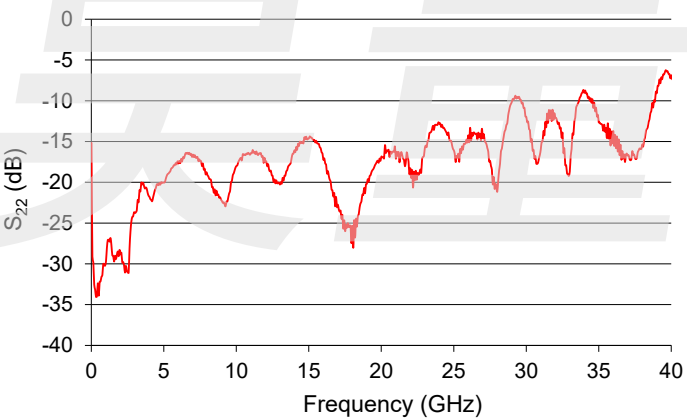

**S<sub>11</sub> Parameter Curve**

Conditions:  $V_{bias} = 12\text{ V}$ ,  $V_{amp} = 1.5\text{ V}$ ,  $V_{xp} = 0.8\text{ V}$ ,  $I_{bias} = 300\text{ mA}$

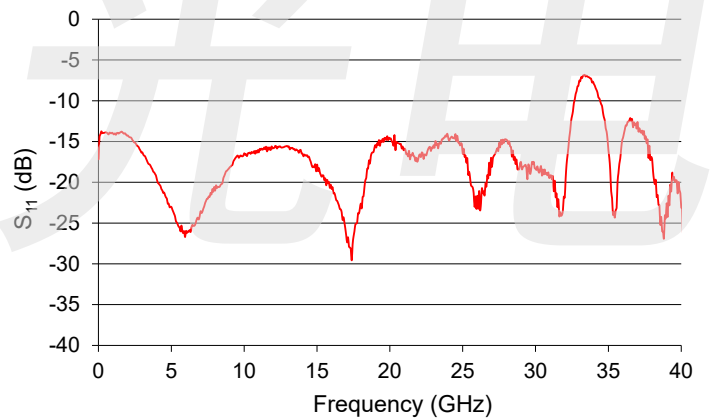

**S<sub>12</sub> Parameter Curve**

Conditions:  $V_{bias} = 12\text{ V}$ ,  $V_{amp} = 1.5\text{ V}$ ,  $V_{xp} = 0.8\text{ V}$ ,  $I_{bias} = 300\text{ mA}$

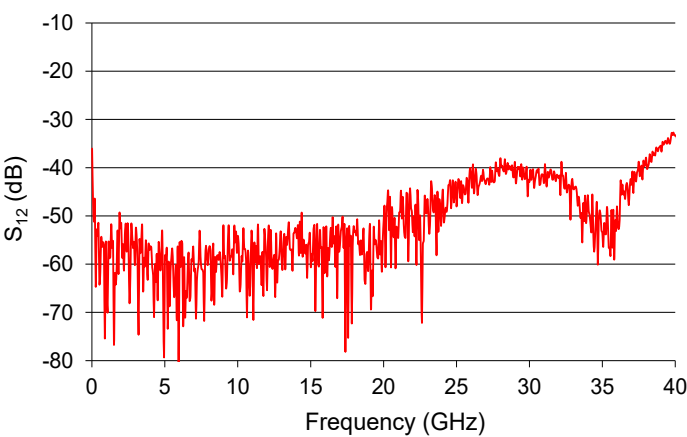

**Typical Output Voltage Amplitude VS Gain Control Vamp Tuning**

Conditions:  $V_{bias} = 12\text{ V}$ ,  $V_{xp} = 1.7\text{ V}$

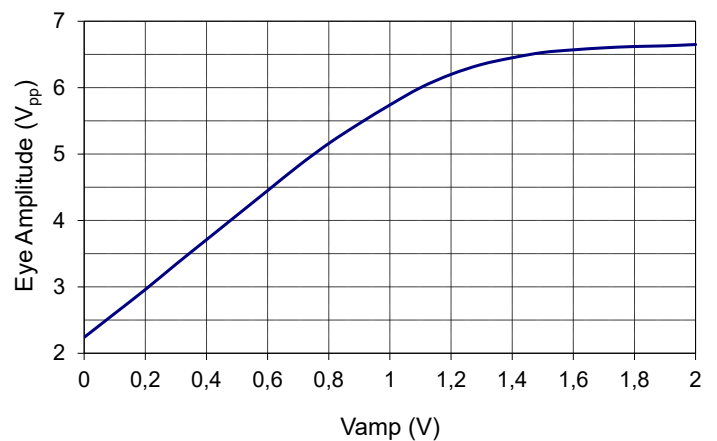

Eye Diagrams

28 Gbps data rate

Conditions: Ratio 1/2, Pattern 2<sup>31</sup>-1

$V_{bias} = 8\text{ V}, V_{amp} = 2.1\text{ V}, V_{xp} = 1.7\text{ V}, I_{bias} = 282\text{ mA}$

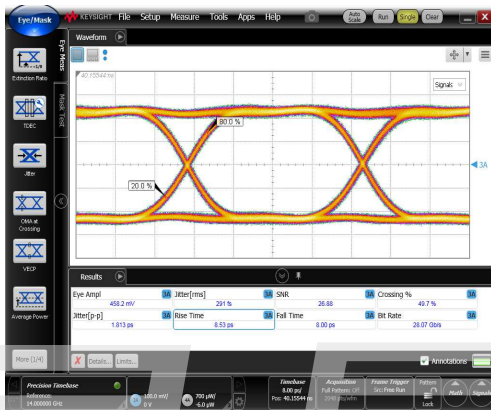

Input signal

Eye amplitude =  $0.45\text{ V}_{pp}$

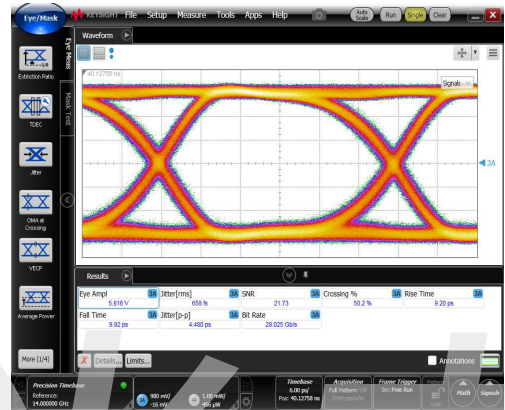

Output response

Eye amplitude =  $5.8\text{ V}_{pp}$

40 Gbps data rate

Conditions: Ratio 1/2, Pattern 2<sup>31</sup>-1

$V_{bias} = 8\text{ V}, V_{amp} = 2.7\text{ V}, V_{xp} = 1.7\text{ V}, I_{bias} = 282\text{ mA}$

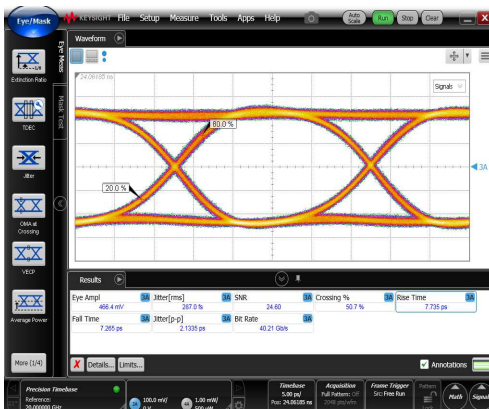

Input signal

Eye amplitude =  $0.45\text{ V}_{pp}$

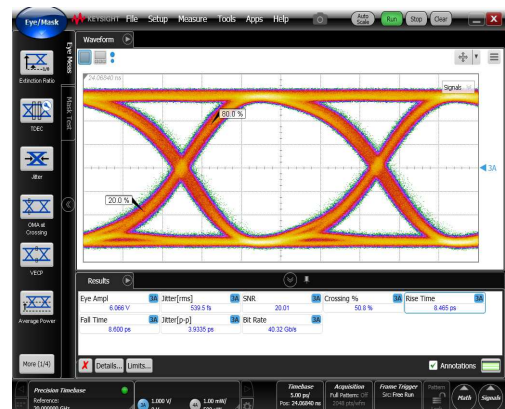

Output response

Eye amplitude =  $6\text{ V}_{pp}$

Electrical Schematic Diagram

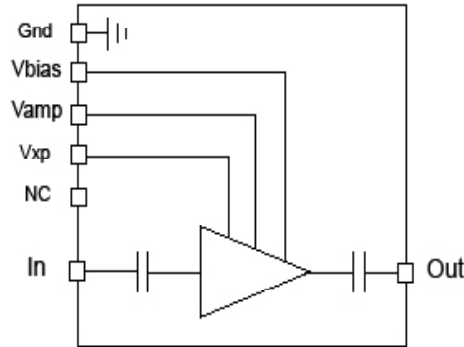

Mechanical Diagram and Pinout

All measurements in mm

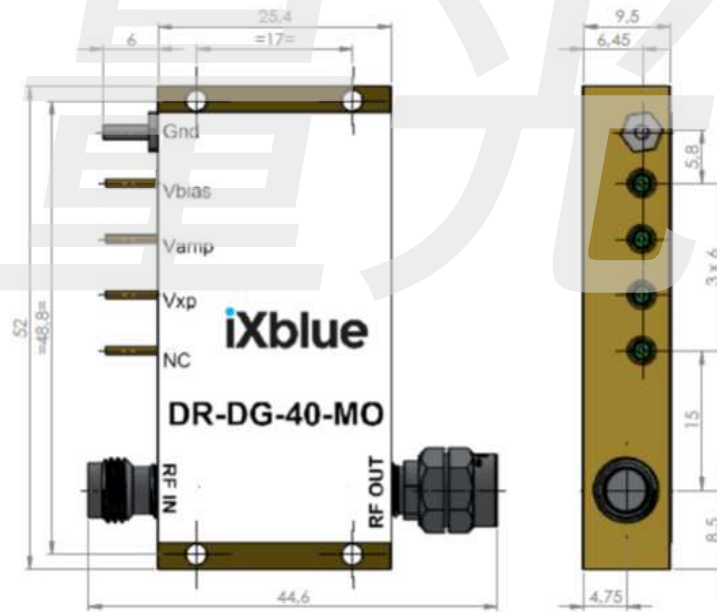

The heat-sinking of the module is necessary. It's user responsibility to use an adequate heat-sink. Refer to page 6 for ixblue recommended heat-sink.

PIN	Function	Unit
IN	RF In	V connector female
OUT	RF Out	V connector male
$V_{bias}$	Power supply voltage	Set a typical operating specific tion
$V_{amp}$	Output voltage amplitude adjustment	Adjust for gain control tuning
$V_{xp}$	Output voltage cross point adjustment	Adjust for cross point control tuning

Mechanical Diagram And Pinout With HS-MO4 Heat-sink

All measurements in mm

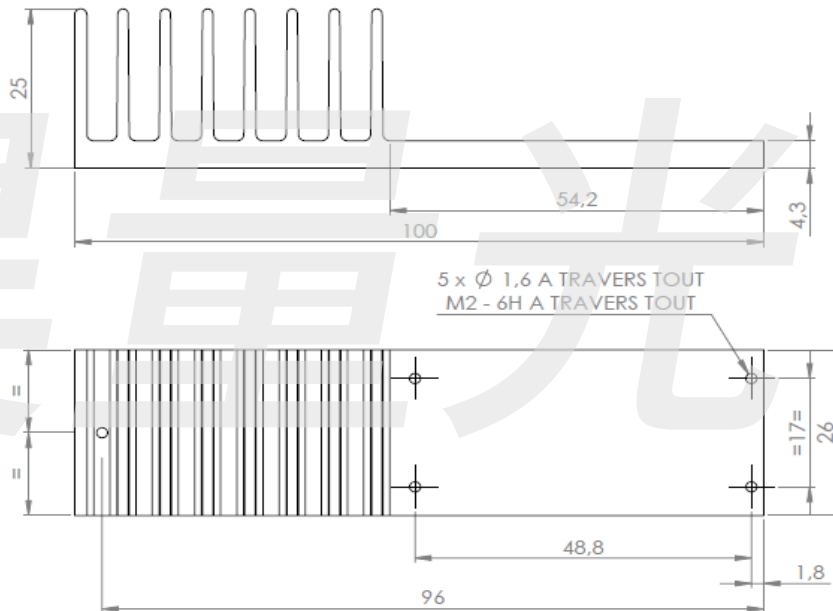
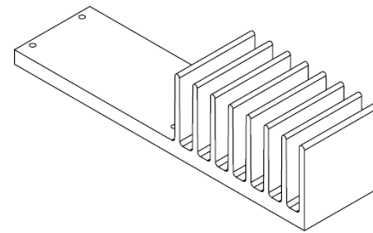

About us

ixblue Photonics produces specialty optical fibers and Bragg gratings based fiber optics components and provides optical modulation solutions based on the company lithium niobate (LiNbO<sub>3</sub>) modulators and RF electronic modules.

ixblue Photonics serves a wide range of industries: sensing and instruments, defense, telecommunications, space and fiber lasers as well as research laboratories all over the world.

3, rue Sophie Germain  
25 000 Besançon - FRANCE  
Tel.: +33 (0)1 30 08 87 43

Aunion Tech Co.,Ltd  
Floor 3, F Building, No. 86 Caobao road, Shanghai 200235 P.R. China  
Tel: +86-21-51083793 Fax:+86-21-34241962  
E-Mail: info@auniontech.com Website: www.auniontech.com