



Bandpass Tunable Filter (Flat-Top)

Short & Long Bandpass Tunable Filter of WLTF-BM- & WLTF-BE- series is built based on free-space optical Fourier transformation combining with diffraction grating to implement passband tuning. Unique optics design produces an access of selecting spatially the part, either long bandpass or short bandpass, of input spectrum and offers flat transmission in passband. Wavelength-tuning is actuated by either a precise micrometer driver or a micro step-motor connected to a PC through a USB interface in which actuation is monitored by a built-in encoder and controlled dynamically in a closed-loop.

Patent-pending optics design offers a great option of bandwidths and tuning ranges with unprecedented low insertion loss and polarization dependent loss (PDL) in the market. Precise tuning mechanism enables filters to provide high wavelength resolution and excellent wavelength-tuning repeatability. Both of manual and electric version filters are available over X-, O-, S-, C-, & L- bands.

Key Features

- Long-pass or short-pass type available
- Unprecedented low insertion loss and polarization-dependent loss (PDL)
- Sharp filter edge roll-off slop
- Up to 120nm wavelength tuning range
- Wavelength range available over X-, O-, S-, C- and L- bands
- High out-band suppression
- High optical power handling

Applications

- ASE noise suppression
- Wideband WDM channel filtering
- Pulse shaping and compression
- Analysis of optical spectrum
- Signal filtering

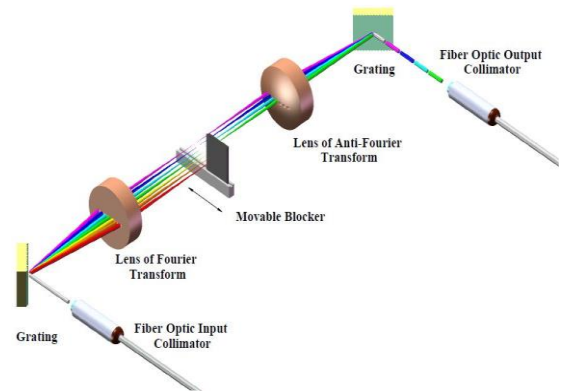

Operating Principle and Tuning Mechanism

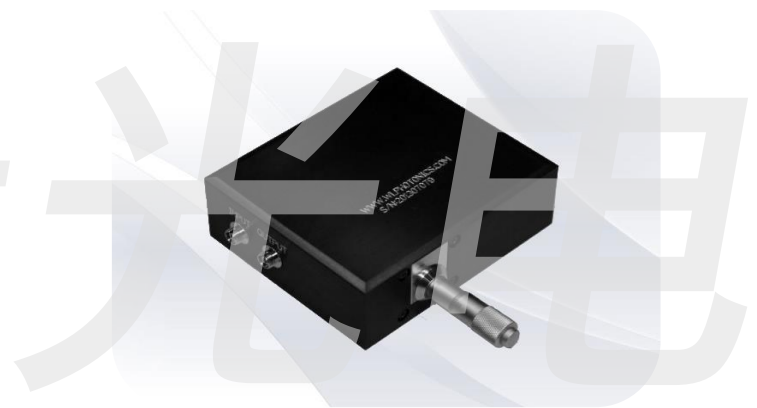

Manual Version of WLTF-BM-S or P



Electric Version of WLTF-BE-S or P



Specifications of Bandpass Tunable Filter (WLTF-BM- or BE-Version)

Center Wavelength	1060nm±15nm	1310nm±15nm	1550nm±20nm	1600nm±20nm
Tuning Range	80nm	100nm	100nm	100nm
Insertion Loss	2.0dB typ. and 3.0dB max. (connector exclusive)			
Polarization-Dependent Loss	0.15dB typ./0.30dB max. over whole tuning range (SM fiber pigtail only)			
Passband Flatness	<0.5dB (measured within any 10% of passband)			
Extinction Ratio	20dB (connector exclusive, PM fiber pigtail only)			
Filter Edge Rolling-Off Slope ¹	35dB/nm for S-version	25dB/nm for S-version	22dB/nm for S-version	20dB/nm for version
	80dB/nm For P-version	60dB/nm For version	55dB/nm For version	50dB/nm For version
	150dB/nm For U-version	120dB/nm For U-version	100dB/nm For U-version	100dB/nm For U-version
Wavelength Resolution	0.02nm			
Wavelength Repeatability	±0.02nm			
Return Loss	>45dB			
Max. Optical Power	500mW (CW). Up to 5.0W(CW) power handling available on request			
Out-Band Suppression	>40dB (for <10nm passband and transmission to the average of background)			
Polarization Mode Dispersion	<0.2ps (SM fiber pigtail only)			
Group Delay	<0.1ps/nm			
Pigtail Fiber Type	HI1060	SMF-28 or SMF-28e		
	Panda PM980 ³	Panda PM1300 ³	Panda PM1550 ³	
Operating Temp.	10°C to 50°C			
Storage Temp.	-10°C to 75°C			
Electric Interface	USB, I ² C and SPI. Or other type interfaces available on request			
Dimension	See drawings below			
Weight	<0.75kg			
Other	RoHS compliant			
Note	¹ Measured from -3dB to -43dB level			
	² High power up to 5.0W (CW) is available on request.			
	³ PM fibers aligned in PM slow axes (fast-axis blocking) unless specified otherwise.			



Dimensions of Manual Tunable Filter (WLTF-BM-S, or -P version)

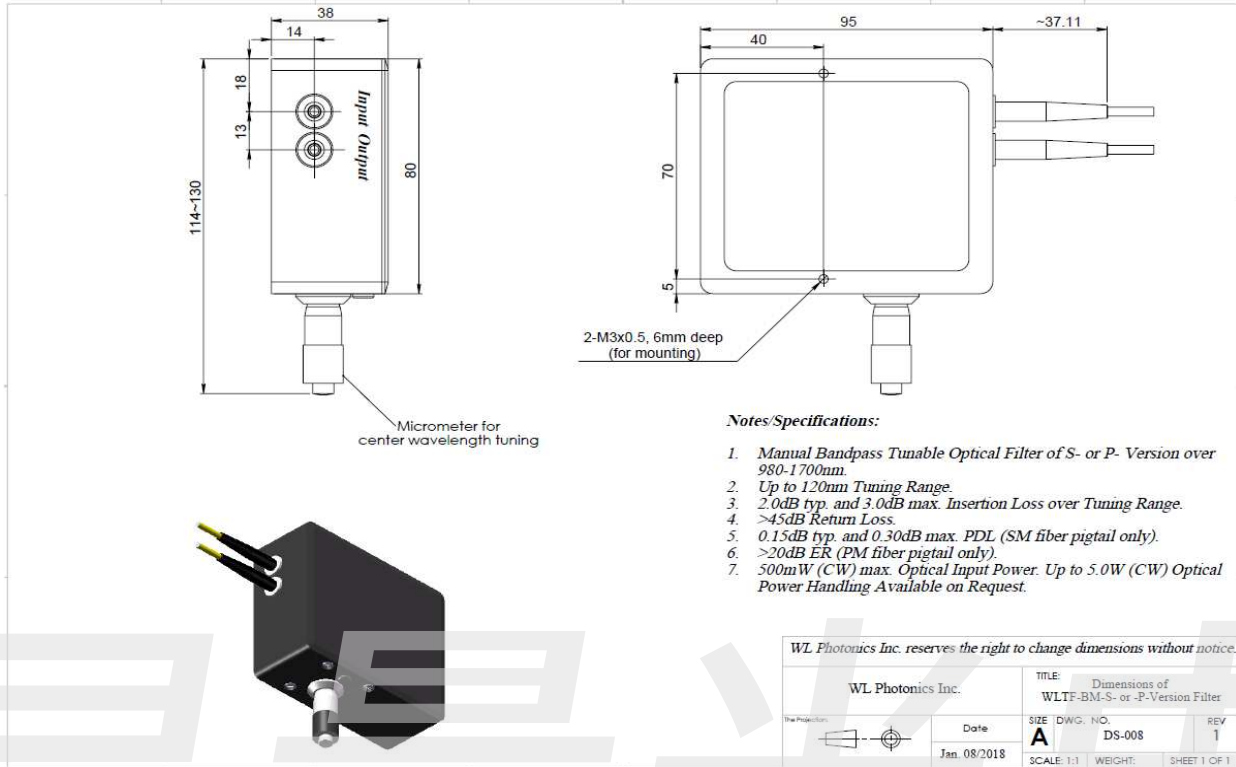

Dimensions of Electric Tunable Filter (WLTF-BE-S or -P-version)

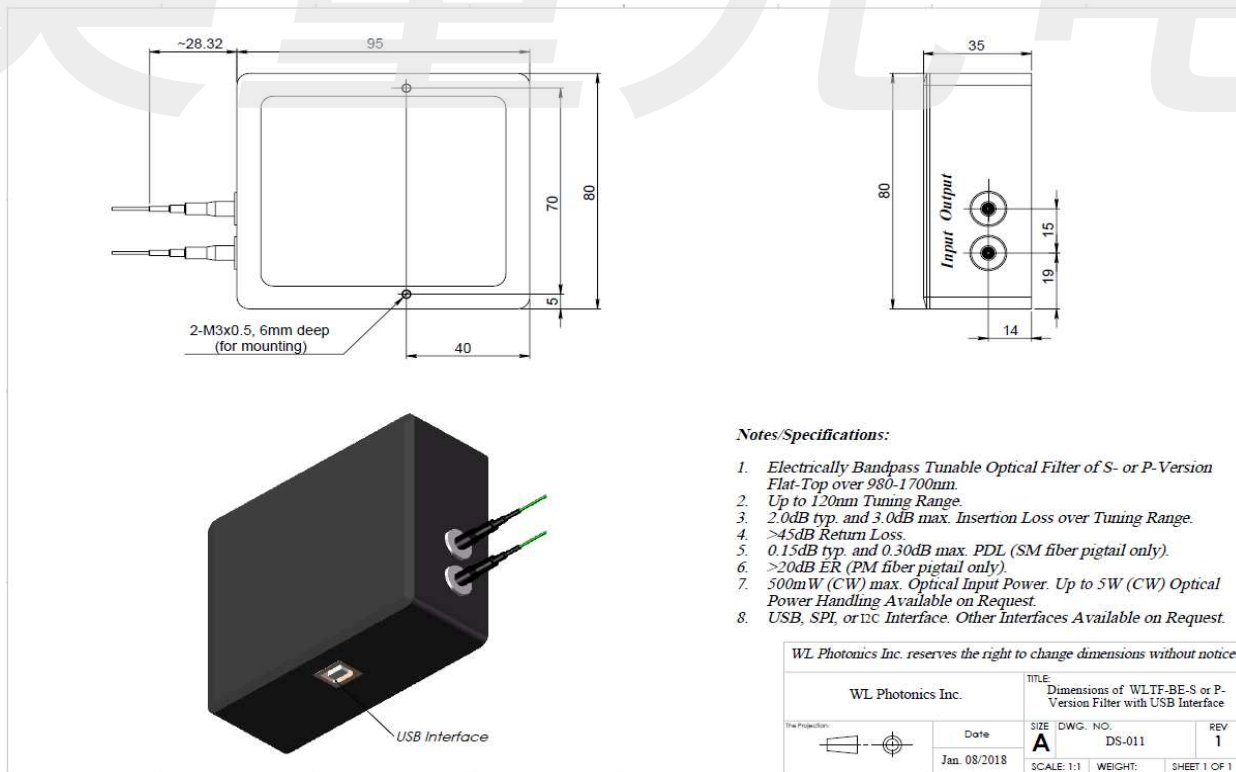

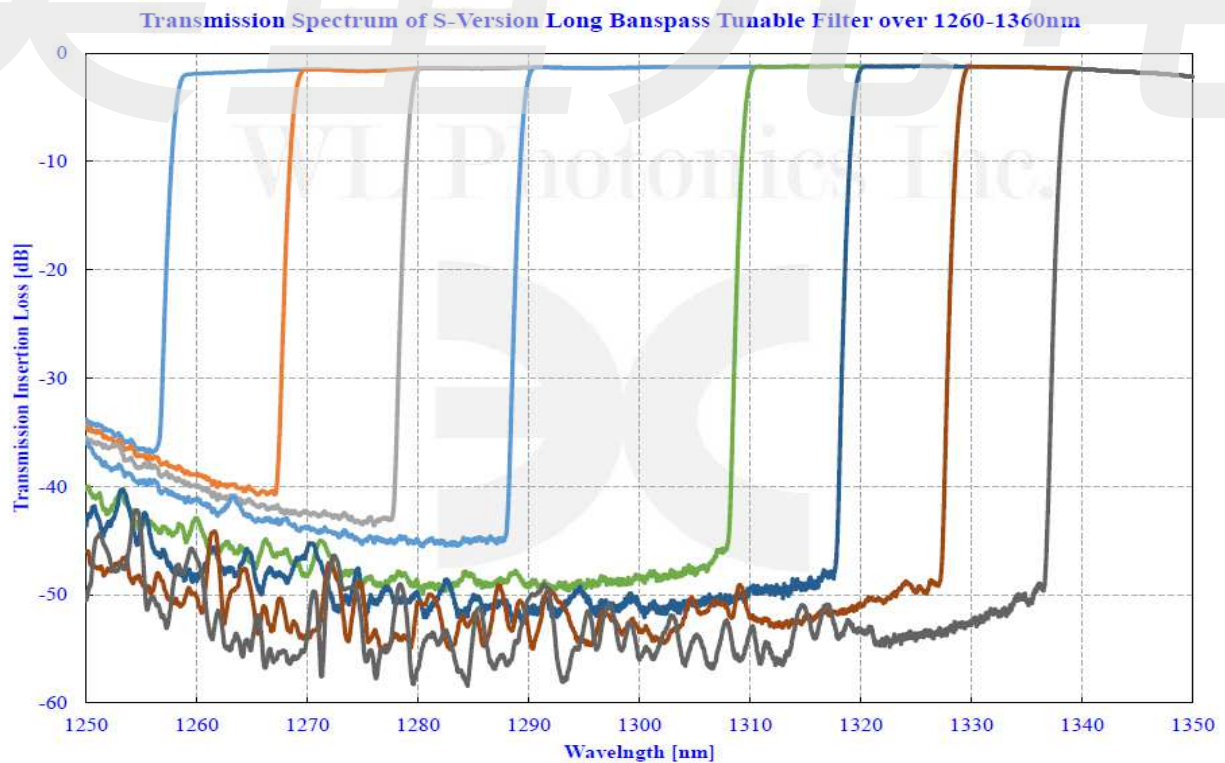
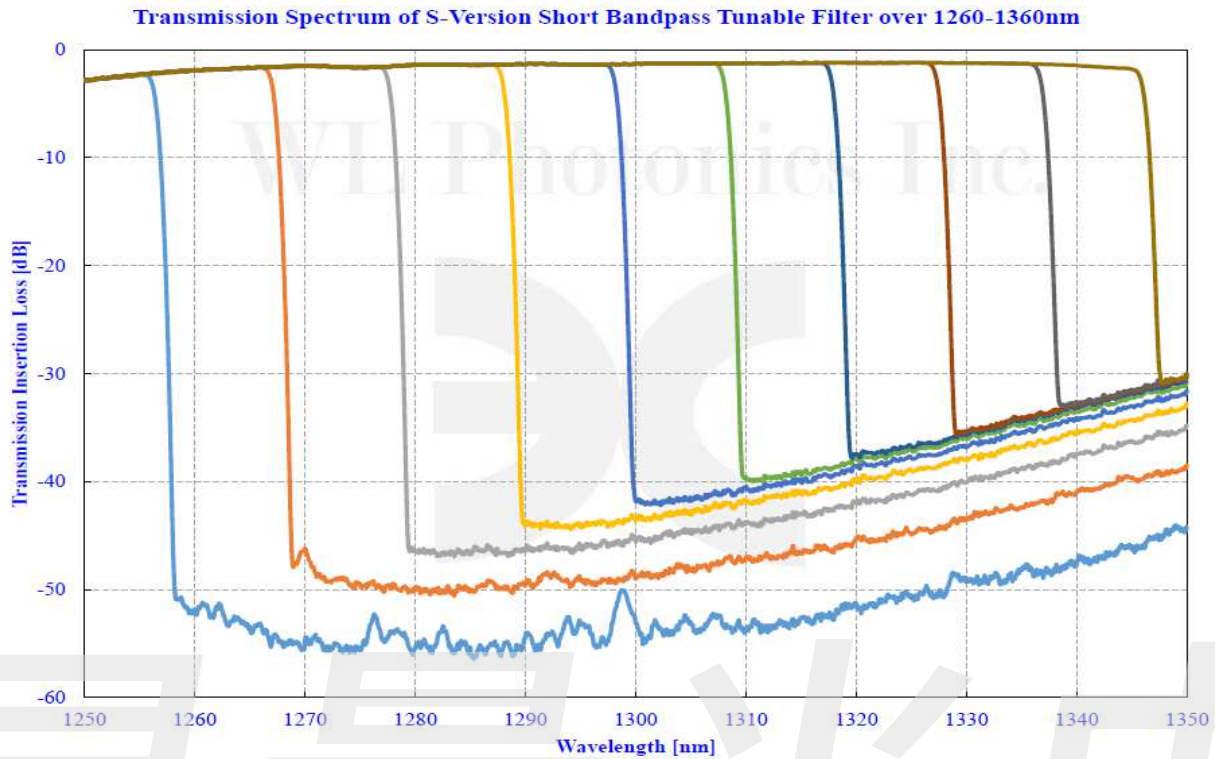

C201307007-3/Jan. 14, 2019

300 Terry Fox Drive, Suite 600, Kanata, Ontario, K2K 0E3, Canada. Phone: +1 613-801-1825

Contact: sales@wlphotonics.com

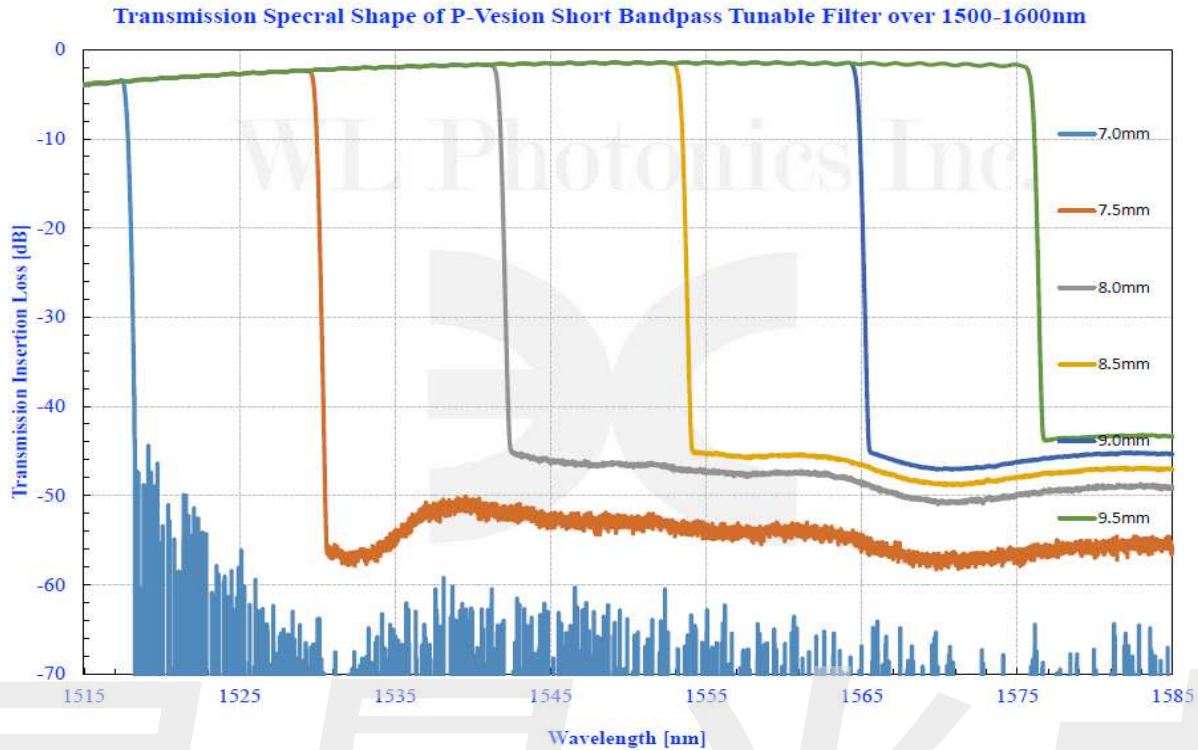

USB interface of S- or P-version electric tunable filters for Filter Wavelength Tuning (FWT) through a PC is equipped with USB-RS232 virtual serial port interface (USB B-type connector). The power supply is provided from either USB directly or an extra 5V DC (on request). It is easy to use any Serial COM Port Software in PC to control FWT, such as HyperTerminal and Tera Term. The command set is very simple and easy to drive the filter to find the home position, go to desirable center wavelengths of transmission band or any indicated positions within actuation range.

Ordering Information

Part Number of Manual Version: WLTF-BM-**A**-**B**-**C**-**D**-**E/F**-**G**

Part Number of Electric Version: WLTF-BE-**A**-**B**-**C**-**D**-**E/F**-**G**-**H**

- A. Version type: **S** is for S-version, **P** is for P-version and **U** is for U-version respectively.
- B. Bandpass type: **L** is for long bandpass type and **S** is for short bandpass type respectively.
- C. Center Wavelength of tuning range in nanometer: **1550** is for 1550nm center wavelength, **1310** is for 1310nm center wavelength and **1050** is for 1050nm center wavelength.
- D. Fiber type: **SM** is for single mode fiber and **PM** is for polarization maintaining fiber.
- E. Pigtail cable diameter in millimeter: **0.25** is for 250 μ m OD buffer fiber, **0.9** is for 900 μ m OD loose tube and **3.0** is for 3.0mm OD cable (only existing for pigtail version).
- F. Pigtail length in meter: **0.5** is for 0.5m long and **1.0** is for 1M long (only existing for pigtail version).
- G. Connector type of either pigtail termination or receptacle interface: such as **FC/APC**, **FC/UPC**, **SC/APC** or **LU/UPC** and **00** is for no connector.
- H. Interface type for electric version: **USB** is for USB interface, **I²C** is for I²C interface and **SPI** is for SPI interface.



Example 1: WLTF-BM-S-L-1550-SM-3.0/1.0-FC/APC

Description: S-version fiber optic polarization-insensitive manually long bandpass tunable optical filter centred @ 1550nm with 1M long, 3.0mm OD loose cabled SMF-28e fiber pigtailed and FC/APC connectors on both ports. 500mW (CW) max. optical input power.

Example 2: WLTF-BM-P-S-1060-PM-0.9/1.0-FC/APC-3.0

Description: P-version fiber optic polarization-sensitive manually short bandpass tunable optical filter @ 1060nm centered @ 1060nm with 1M long, 900µm OD loose cabled Panda PM980 fiber pigtailed aligned in PM slow axes (fast-axis blocking) and FC/APC connectors on pigtail ends. 3.0W (CW) max. optical input power.

Example 3: WLTF-BE-P-S-1060-PM-0.9/1.0-FC/APC-USB-5.0

Description: P-version fiber optic polarization-sensitive electrically short bandpass tunable optical filter @ 1060nm center wavelength with 1M long, 900µm OD loose cabled Panda PM980 fiber pigtailed aligned in PM slow axes (fast-axis blocking) and FC/APC connectors on both pigtail ends. 5.0W (CW) optical input power and USB interface.

Example 4: WLTF-BE-S-L-1310-SM-FC/APC-I²C

Description: S-version fiber optic polarization-insensitive electrically long bandpass tunable optical filter centered @ 1310nm with receptacle input and output interface for FC/APC connectors. SMF-28 operating fiber, 500mW (CW) max. optical input power and I²C digital interface.