

## Data sheet mp6 micropump



### Summary

This document contains detailed information on the mp6 micropump series by Bartels Mikrotechnik.

The mp6 micropump by Bartels Mikrotechnik is available, industrialized and commercialized. This micropump is a positive displacement membrane pump utilizing piezo buzzers. With a volume of 2250 mm<sup>3</sup> (30 mm x 15 mm x 5 mm) it is dimensionally very beneficial. It is built up in a layer-by-layer (stack) setup, and combined and sealed in laser welding process.

The absorbing and transparent plastic material can be melted by a laser, so that the melted mass unites the parts. There is no glue in contact with the fluid, but only the material the micropump is made from. Standard material is PPSU. Due to the unibody and the fact that the pump does not contain any moving parts, it is sterilizable, robust and reliable with a lifetime with more than 5000 h.

## 1 Contents

1	Revision History.....	3
2	Technical Specifications mp6 series .....	3
3	Fluidic Specifications mp6 series.....	4
3.1	Dependency of pressure and flowrate .....	4
3.2	Priming.....	5
3.3	Cleaning.....	5
3.4	Performance with the three driver options.....	5
3.5	Typical performance of mp6 series depending on viscosity.....	7
3.6	Parallel and series connection .....	8
3.7	Bi-directional pumping.....	9
3.8	Pump Compatibility.....	10
3.9	Material Compatibility.....	10
3.10	Sound Emission.....	12
3.11	Low Flow Rates for Liquids (water) .....	13
4	Electronic Specifications mp6 series .....	15
4.1	Electronic signal .....	15
4.2	Pin-Layout.....	15
5	Mechanical specifications .....	16
5.1	Geometry and Handling .....	16
5.2	Internal Volumes .....	17
5.3	Mounting.....	18
6	Ordering Information and Packaging mp6 series.....	18
7	Important Notices.....	19
7.1	Warranty.....	19
7.2	Warning, Personal Injury.....	20
7.3	Declaration of conformity.....	21
8	Company information.....	21

## 1 Revision History

### Changes from v2.0 to v2.1

- New sub chapter: 5.2 Internal Volumes added
- Graphs in 3.4 updated in higher resolution

## 2 Technical Specifications mp6 series

Table 1 General information mp6 series<sup>1</sup>

mp6 series	
Pump type	piezoelectric diaphragm pump
Number of actuators	2
Dimensions without connectors	30 x 15 x 3,8 mm 1.1811 x 0.5906 x 0.1498 in.
Internal Volume	30 µl
Weight	2 g
Fluidic connectors	barbed tube clip (outer diameter 1.9 mm, length 3.5 mm) <sup>2</sup>
Electric connector	flex connector 1.25 mm pitch
Power consumption	~ 50 mW <sup>3</sup>
Self-priming	yes <sup>4</sup>
Pumping media	Liquids and gases
Operating temperature	0–70°C
Sterilization options	Autoclaving, EtO, Radiation (E-Beam or gamma), Alcohol
Burst pressure	1.8 bar
Life time	5000 h <sup>3</sup>
IP code	IP33 <sup>5</sup>
Material in contact with media	Polyphenylsulfone (PPSU), Polypropylene (PP; only mp6-sol) <sup>6,7</sup>
Suitable pump driver	mp-labtronix, mp-Highdriver, mp-Lowdriver, mp-Highdriver4

<sup>1</sup> Typical values can vary under application conditions. Content is subject to changes without notice.

<sup>2</sup> Recommended tubing: Tygon tubing 1.3 mm inner diameter.

<sup>3</sup> Conditions: settings mp-labtronix: 100 Hz, 250 V, SRS

<sup>4</sup> Conditions: air, room temperature 23°C, settings mp-labtronix: 300 Hz, 250 V, SRS, the max. volume flow will be reached after a few minutes of operation time.

<sup>5</sup> Can be changed to IP44.

<sup>6</sup> For media compatibility details please see section 3.9 in this document.

<sup>7</sup> Other materials available on request

The mp6 series consists of three different pump types: mp6-liq, mp6-gas and mp6-gas+.

The mp6-liq is meant to pump mainly water-based solutions. It can pump liquids at highest parameters for liquid flow rate and liquid pressure.

In addition, there are the gas versions of the mp6 series – mp6-gas and mp6-gas+. Both types are still able to pump liquids, but they are optimized for gas applications. Another option is to prime a fluidic system, in that case the mp6-gas versions are recommended.

*Please note: All pump types are able to run both fluids, liquids and gases.*

The following table shows typical fluidic values at standard driving and environment parameters from our 100% OQC. These values were measured in a defined environment in a defined fluidic system at 25°C, 1 bar atmospheric pressure, humidity: 70%. For driving the pumps, the mp-Labtronix was used at 250Vpp/100Hz/SRS for water and 250Vpp/300Hz/SRS for gas. Values can vary under application conditions.

Table 2 Comparison charts mp6 series for water and air

Water						
Pump type	Min. Flowrate [μl/min]	Typ. Flowrate [μl/min]	Max. Flowrate [μl/min]	Min. Pressure [mbar]	Typ. Pressure [mbar]	Max. Pressure [mbar]
mp6-liq	6000	8000	12000	500	600	1000
mp6-gas	6000	8000	12000	500	600	1000
mp6-gas+	6000	8000	12000	500	600	1000

Air						
Pump type	Min. Flowrate [μl/min]	Typ. Flowrate [μl/min]	Max. Flowrate [μl/min]	Min. Pressure [mbar]	Typ. Pressure [mbar]	Max. Pressure [mbar]
mp6-liq	12000	18000	40000	80	90	200
mp6-gas	20000	25000	40000	100	120	200
mp6-gas+	20000	30000	40000	150	160	200

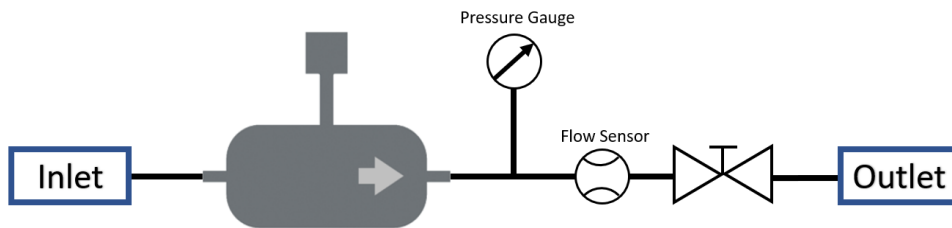

Figure 1 Schematic of OQC in production line at Bartels Mikrotechnik

### 3 Fluidic Specifications mp6 series

#### 3.1 Dependency of pressure and flowrate

Of course, the flowrate of the mp6 micropumps can be adjusted electronically and depends on the backpressure as the following diagram shows in principle.

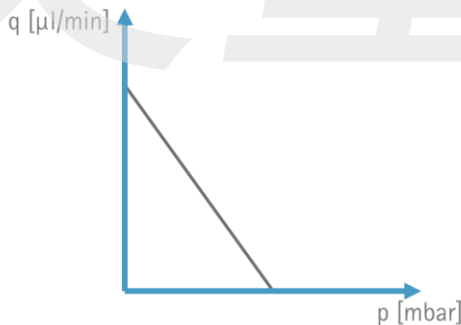

Figure 2 General dependency flow rate/ backpressure

At maximum backpressure, which can be a system pressure or a hydrostatic pressure, the mp6 micropump needs to face, there is no flow anymore. But the mp6 can withstand or rather keep a certain pressure.

See the diagram below for an example: The mp6 micropump is able to reach a pressure value of up to 150 mbar for gases which equals a hydrostatic pressure of 150 cm. Now, if the height distance of a source reservoir to a target reservoir is 150 cm, the mp6 will not be able to generate any flow. If a source is only 100 cm lower than a target reservoir, the mp6 can suck from that reservoir and will be able to fill up the system.

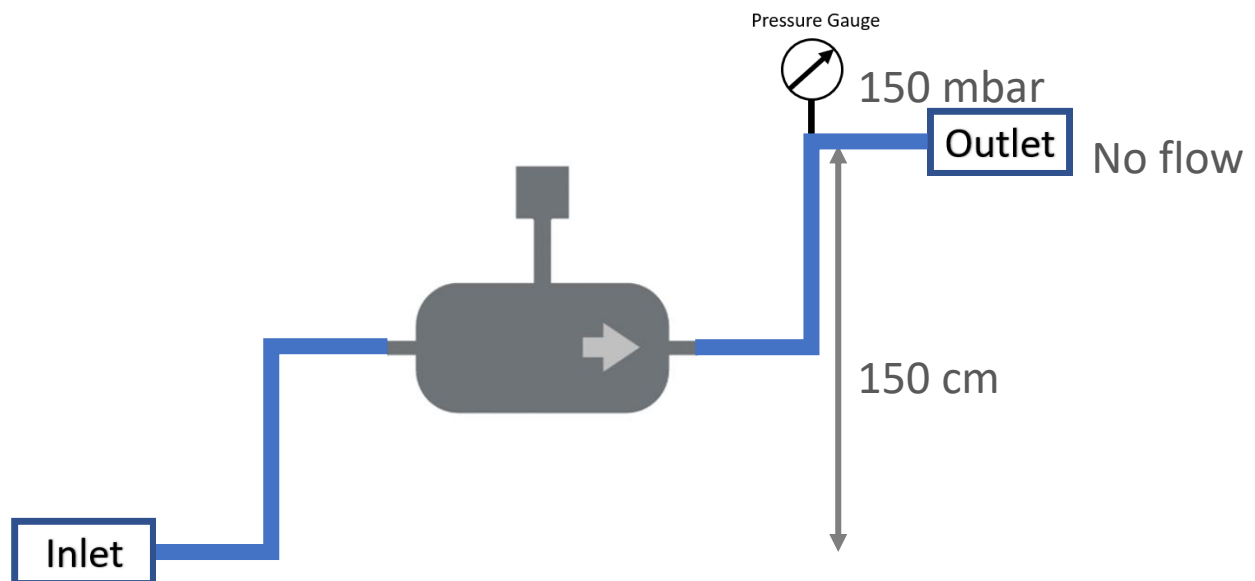

Figure 3 Example increased pressure due to height difference in the system

### 3.2 Priming

The mp6 micropumps are able to transport liquids and gases. This fact allows the mp6 to suck from a source reservoir, transporting the liquid to a target reservoir, while pumping out the air on itself. It is recommended to start with the highest voltage that is possible and a frequency of at least 300 Hz to remove the air. As soon as the liquid reaches the micropump one needs to switch to a lower frequency for best performance, e.g. 100 Hz for water.

Another option is to apply a negative pressure at the outlet. Recommended is a syringe for manual priming. It is also possible to connect an external pump, e.g. a second mp6, only for priming the first mp6. **Flushing is only possible in pump direction! Negative pressure at outlet is rather recommended than positive pressure at inlet!**

### 3.3 Cleaning

For a thorough cleaning of the mp6 micropumps we recommend using Isopropyl alcohol (IPA). One can either rinse the system by sucking in the IPA with a syringe from the outlet or by driving the mp6 micropump conveying IPA or Ethanol for a few minutes. Afterwards, we suggest to rinse the micropump with distilled water to get rid of any leftover alcohol from the pump channels and chambers. The pump can be washed by pumping or by flushing with the help of a syringe. **Flushing is only possible in pump direction! Negative pressure at outlet is rather recommended than positive pressure at inlet!**

### 3.4 Performance with the three driver options

As said before, the flowrate of the mp6 micropumps can be adjusted electronically. Accompanying to our mp6 micropumps we offer integrated driver solutions. The charts listed below showcase the trend of flowrates and pressures vs. the peak-to-peak voltage for different signal frequencies (for distilled water or air).

**mp-Highdriver**

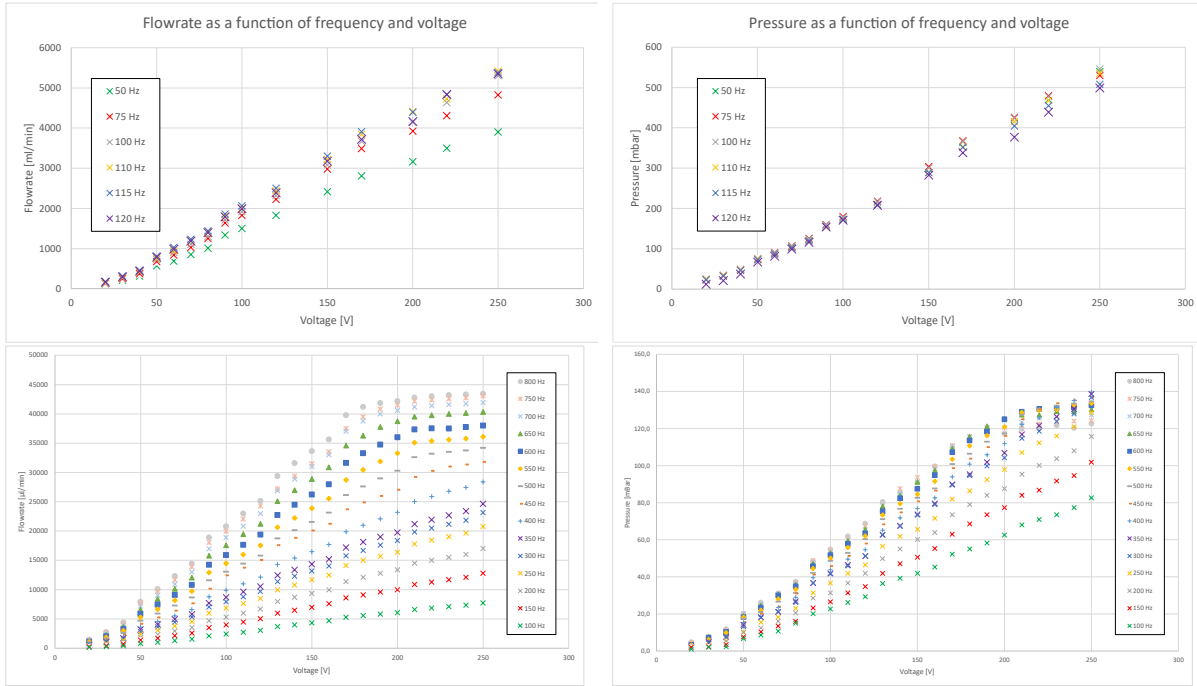

Figure 4 Typical mp-Highdriver flow rates for water (top left), water pressure (top right), flow rates for air (bottom left), air pressure (bottom right)

**mp-Lowdriver**

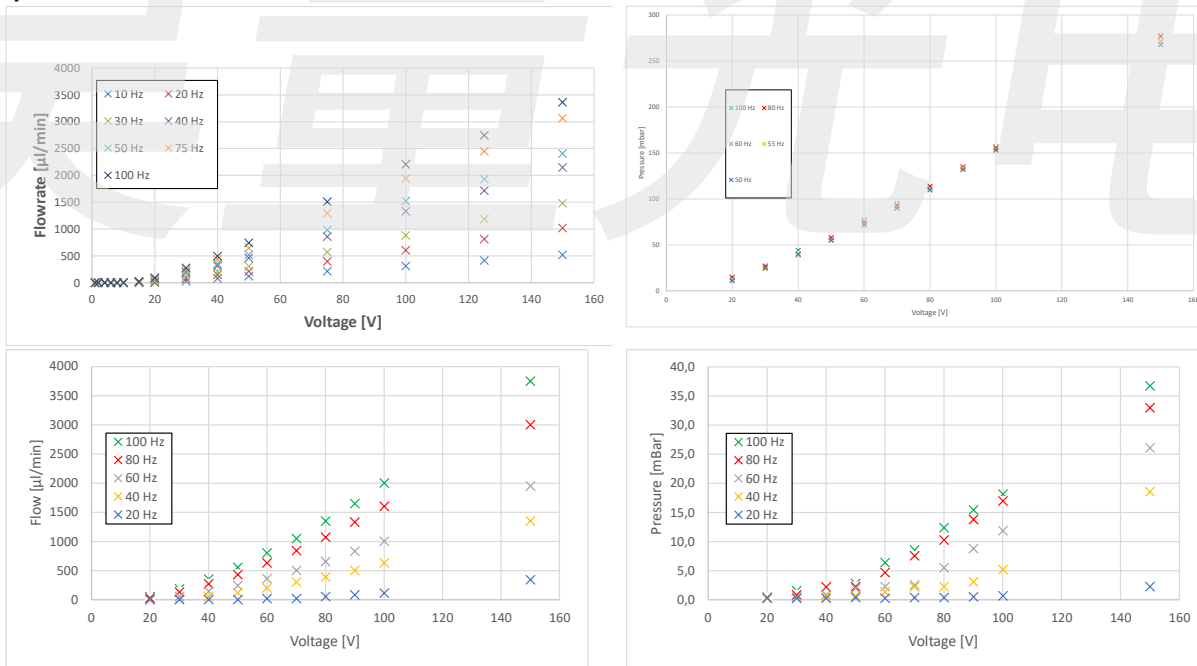

Figure 5 Typical mp-Lowdriver flow rates for water (top left), water pressure (top right), flow rates for air (bottom left), air pressure (bottom right)

**mp-Labtronix**

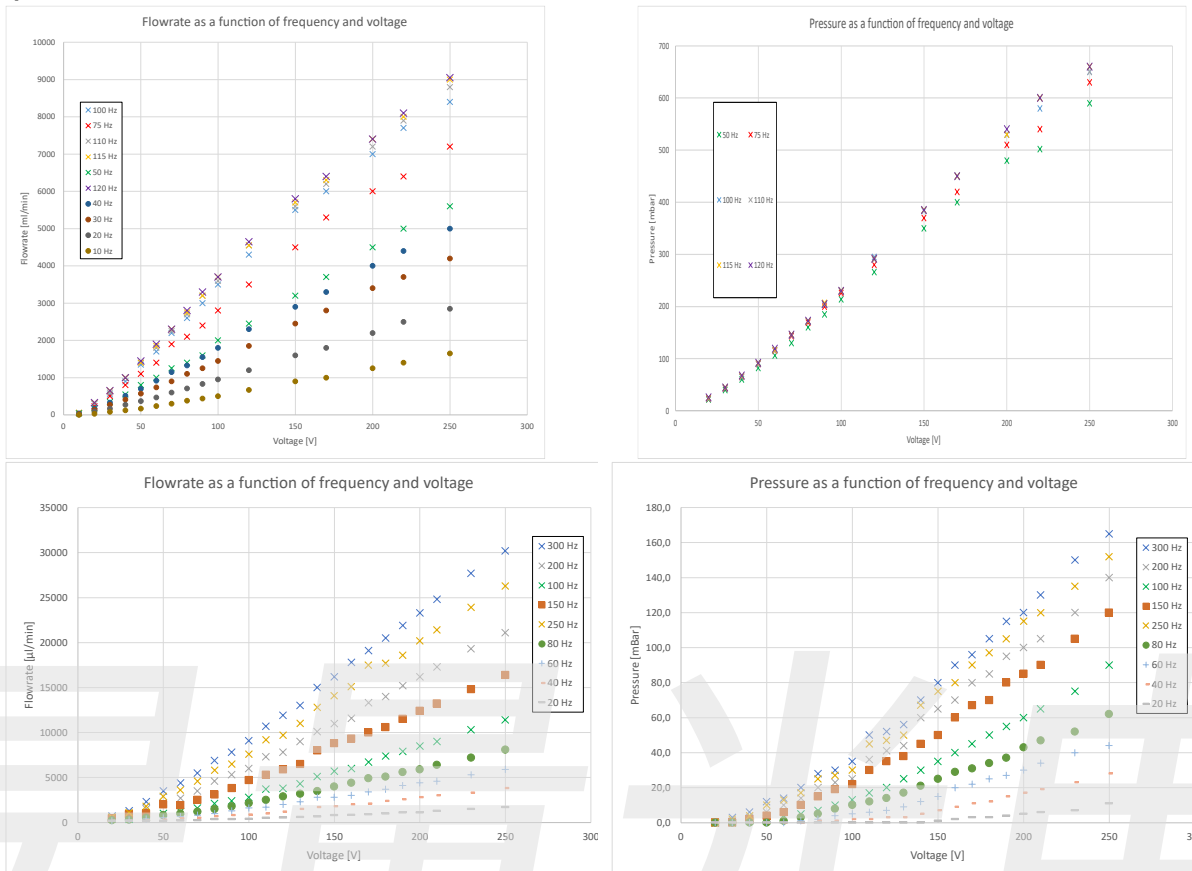

Figure 6 Typical mp-Labtronix flow rates for water (top left), water pressure (top right), flow rates for air (bottom left), air pressure (bottom right)

### 3.5 Typical performance of mp6 series depending on viscosity

The micropumps performance is dependent on the viscosity of the conveyed liquid. The following figure demonstrates the difference between distilled water (1mPas) and various glycerine-water mixtures.



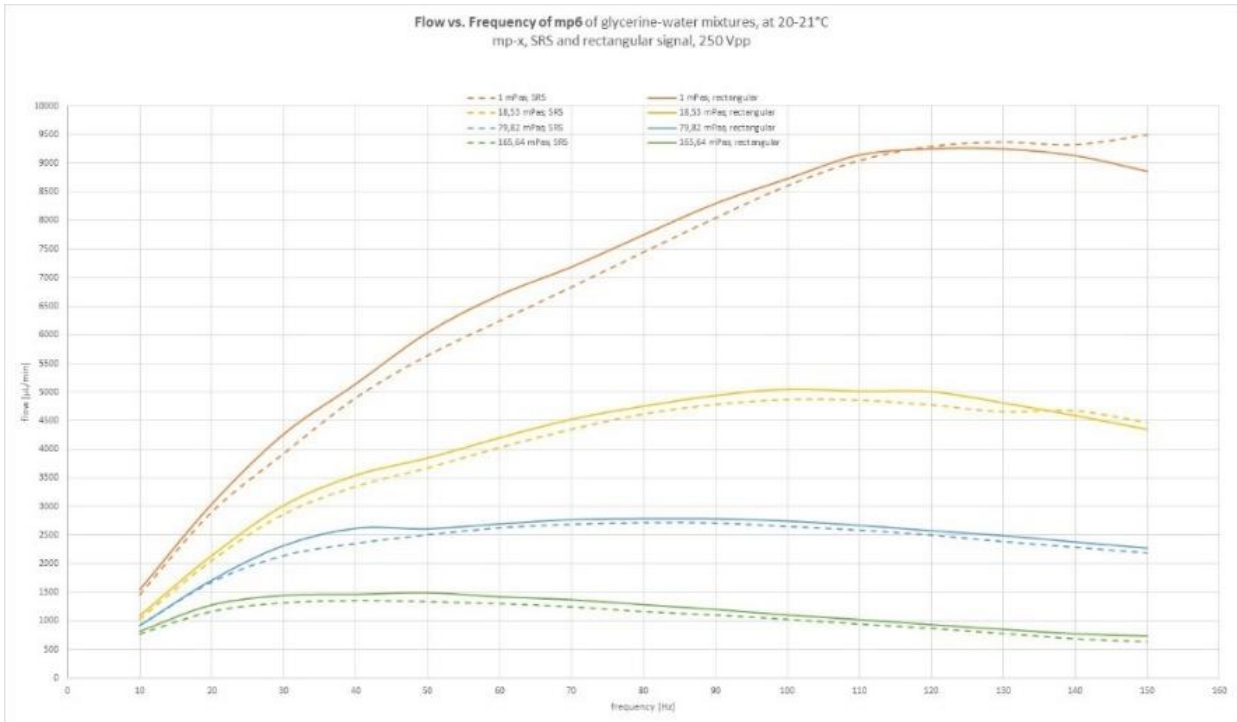
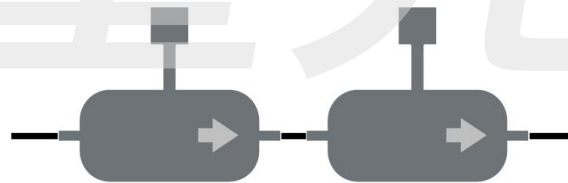

Figure 7 Difference in flow vs. frequency between distilled water (1mPas) and various glycerine-water mixtures

### 3.6 Parallel and series connection

The micropumps can be combined to achieve higher flow rates or pressure than the single unit can generate.

With series connection, the pressures add up.



With parallel connection, the volume flows add up.

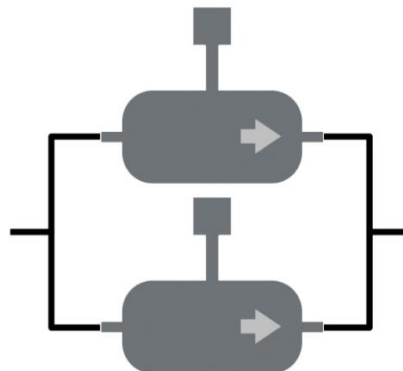

The following diagrams prove the fact that pumps in series or respective in parallel increase the pressure or flow rate:



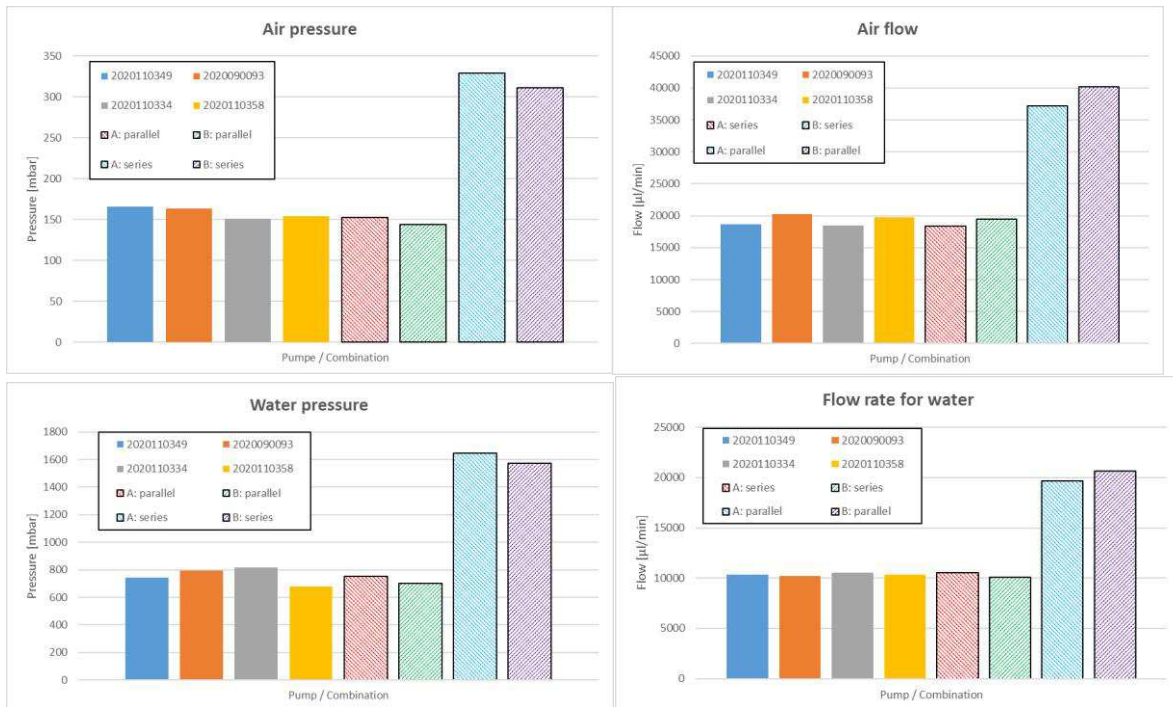

### 3.7 Bi-directional pumping

The mp6 micropumps are unidirectional due to the pressure driven valves inside. Here two simple setups for bidirectional pumping are demonstrated. The figure below shows an assembly of four active Valves, fluid source and target, the mp6 micropump as well as a reference flow sensor. We divided the four valves in two corresponding pairs, red and blue. Pairwise open or closed, they imply a change of direction for the liquid flow.

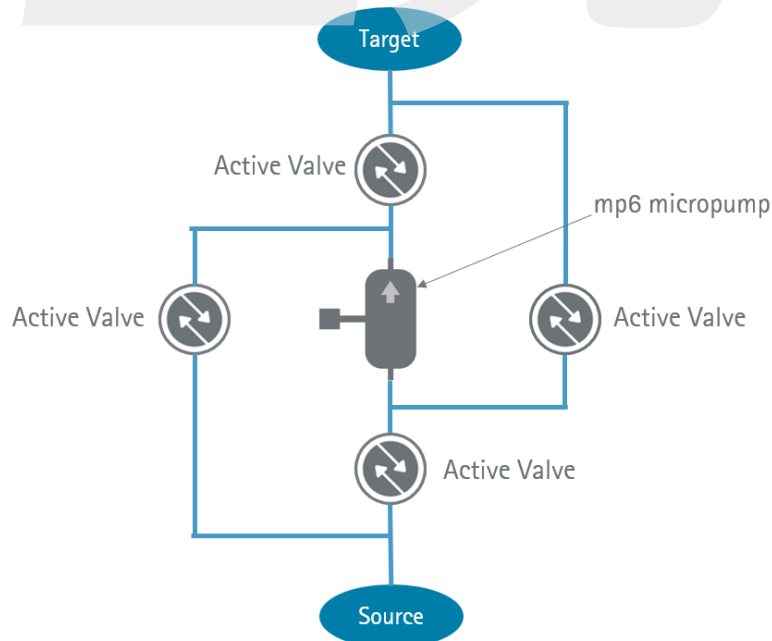

Figure 8 Block diagram for a bidirectional driven mp6 micropump, assisted by a smart combination of four Takasago valves.

Another option is using two micropumps in opposite direction and two 2/2-way valves as shown below.

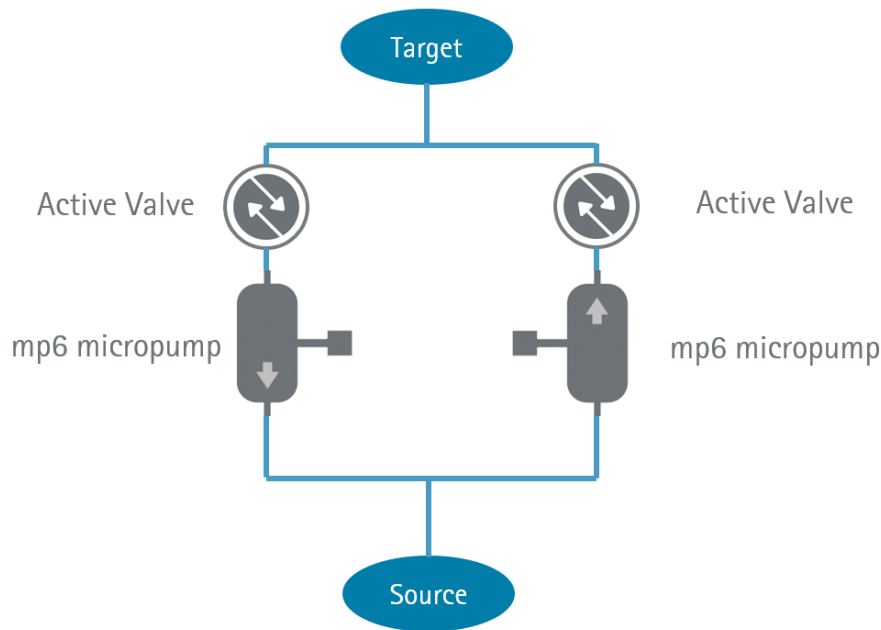

Figure 9 Block diagram for using two micropumps in opposite direction and two 2/2-way valves

### 3.8 Pump Compatibility

#### Impact of liquids on pump performance\*

The following table shows the compatibility of the pump performance degradation due to the absorption of liquid molecules that change the mechanical behaviour of the internal parts of the pump. This effect has got an impact during the pumping process, but it is reversible. The pump is not permanently damaged.

Table 3 Pump Compatibility

Reagent	Concentration (%)	PPSU (mp6 liq, gas, gas+)
Acetone	100	-
Acetic acid	100	o
Ethanol	100	-
Ethyl acetate	100	-
Glycerin	60	++
Isopropanol	100	o
Methanol	100	-
Cleaning gasoline	100	o
Vacuum pump oil	100	+
Sodium hydroxide	0,2	++

\* Longterm measurements with mp6 micropumps at 250Vpp/100Hz for two weeks

\*\* Classification

- ++ Excellent: Little to no effect
- + Good: No serious loss of properties
- o Fair: Some negative effects, some useful properties retained
- Poor: Sever attack or rupture

### 3.9 Material Compatibility

#### Chemical resistance of polyphenylsulfone by immersion\*

The following table shows the chemical impact of liquids on the wetted parts of the pumps. In this case the parts react with the liquids and are permanently damaged.

### Organic Chemicals

Table 4 Chemical Compatibility

Reagent	Concentration (%)	Weight change (%)	Classification** PPSU (mp6 liq, gas, gas+)
1,1,1-Trichloroethane	100	0,0	+
Acetic acid - glacial	100	0,0	+
Acetic anhydride	100	+1,0	-
Acetone		100	-
Benzene		100	0
Butanol	100	0,0	++
Butyl acetate		100	++
Carbitol solvent	100	0,0	++
Carbon tetrachloride	100		++
Citric acid	100	+0,5	+
Cyclohexane	100	0,0	++
Ethanol		100	0
Ethyl acetate		100	-
Ethylene glycol	100	-0,4	+
Formaldehyde	40	+0,4	+
Formic acid	10	+0,6	+
Glycerol	100	0,0	++
Methanol	100	+0,9	0
Toluene		100	0

### Inorganic Chemicals

Reagent	Concentration (%)	Weight change (%)	Classification** PPSU (mp6 liq, gas, gas+)
Hydrochloric acid	20	+0,2	++
Hydrochloric acid	37	+0,2	0
Nitric acid	20	+0,5	+
Nitric acid	71	+26,9	-
Oleic acid	100	0,0	++
Potassium hydroxide	10	+0,5	+
Sodium hydroxide	10	+0,5	+
Sulfuric acid	50	+0,1	+
Sulfuric acid	97	-11,3	-

### Functional Fluids

Reagent	Concentration (%)	Weight change (%)	Classification** PPSU (mp6 liq, gas, gas+)
Brake fluid	100	-0,2	0
Gasoline	100	+0,1	0
Hydraulic oil LO-1	100	0,0	++
Jet fuel JP-4	100	0,0	0
Kerosene	100	0,0	++
Motor oil 10W-40	100	0,0	+

Skydrol® 500B	100	-0,3	-
---------------	-----	------	---

\* Test specimens of polyphenylsulfone were immersed in a variety of common reagents for seven days at room temperature. The effects were monitored by measuring the change in weight and noting any change in appearance.

\*\* Classification

- ++ Excellent: Little to no effect
- + Good: No serious loss of properties
- o Fair: Some negative effects, some useful properties retained
- Poor: Severe attack or rupture

Next to aqueous solution this plastic exhibits a good chemical resistance against diluted acids and many organic solvents. Furthermore it is resistant against diluted alkali solutions. Most organic chemicals, with exception of ketones, have no influence to polyphenylsulfone in the tested time slot. From the tested inorganic reagents concentrated acids have a damaging effect to polyphenylsulfone.

As this data was determined under restricted test conditions, we recommend verifying the compatibility of the pump directly with the pumped media in the customer application. If your media is not compatible with polyphenylsulfone or if you need a different material for the mp6-hyb, it is possible to change the material on a customer basis to suit your requirements.

Please note that Bartels Mikrotechnik can't assume any warranty and liability if a pump gets damaged through the pumping media.

### 3.10 Sound Emission

Driving parameters: 250 V, 100 Hz, mp-x controller

Measurement of 5 pumps, no major deviations between the pumps were observed.

Gas performance	Sound level [dB[A]] sine signal	Sound level [dB[A]] SRS signal	Sound level [dB[A]] rectangular signal
Next to pump body	33.5 - 35	50 - 51	66.6
0.3 m distance	33.5 - 35	40.5	53.4
1 m distance	33.5 - 35	40	52

Driving parameters: 250 V, 300 Hz, mp-x controller

Measurement of 5 pumps, no major deviations between the pumps were observed.

Gas performance	Sound level [dB[A]] sine signal	Sound level [dB[A]] SRS signal	Sound level [dB[A]] rectangular signal
Next to pump body	33.5 - 35	65 - 67	69.8
0.3 m distance	33.5 - 35	50.5 - 52	54.6
1 m distance	33.5 - 35	47.5	53

Driving parameters: 250 V, 100 Hz, mp-x controller, pump is filled with water

Measurement of 5 pumps, no major deviations between the pumps were observed.

Water performance	Sound level [dB[A]] sine signal	Sound level [dB[A]] SRS signal	Sound level [dB[A]] rectangular signal
Next to pump body	33.5 - 35	38.5	39.2
0.3 m distance	33.5 - 35	33.5 - 35	36.6
1 m distance	33.5 - 35	33.5 - 35	35.6

Driving parameters: 250 V, 300 Hz, mp-x controller, pump is filled with water

Measurement of 5 pumps, no major deviations between the pumps were observed.

Water performance	Sound level [dB[A]] sine signal	Sound level [dB[A]] SRS signal	Sound level [dB[A]] rectangular signal

Next to pump body	38.8	43.8	43.8
0.3 m distance	35.4	37	37.8
1 m distance	33.5 - 35	35	35.4

### 3.11 Low Flow Rates for Liquids (water)

Option A: Low power values for low liquid performance

Both mp-Labtronix and mp-Lowdriver can be adjusted down to 1 Vpp amplitude and less than 10 Hz frequency. These characteristics lead to the fact that the mp6 can reach low fluid performances.

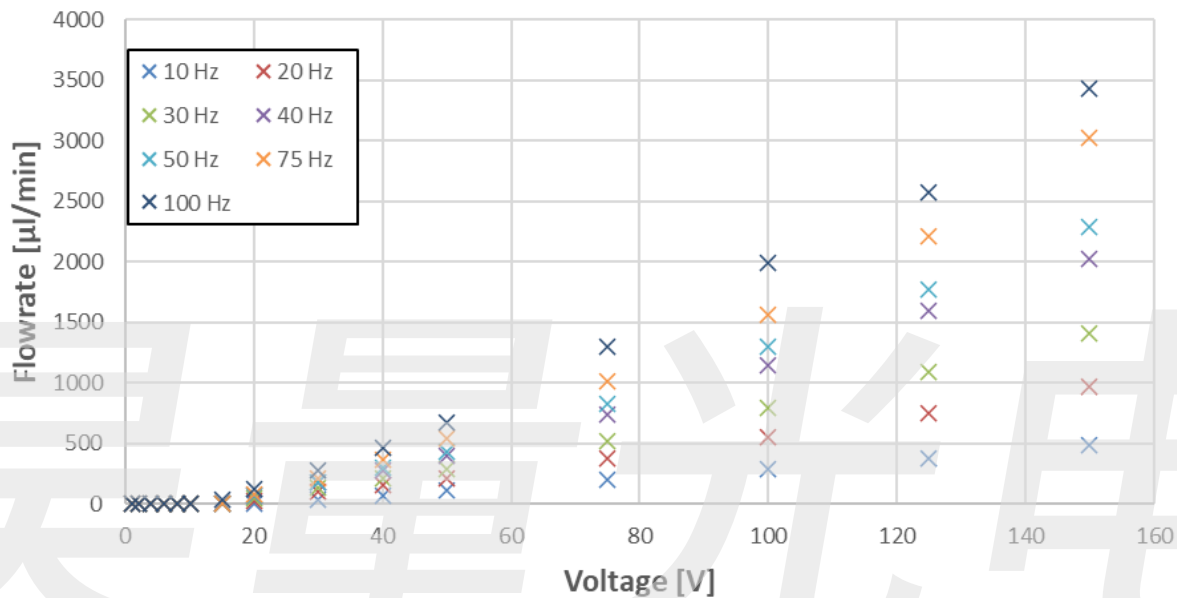

Figure 10 Example for mp6 run by mp-Lowdriver pumping water

Option B: High frequencies for low liquid performance

Due to mass inertia and shear forces due to viscosity one can decrease flow rates by increasing the frequency. Increasing the frequency means to increase the acceleration by keeping forces constant. This behaviour can be realised by all the available drivers.

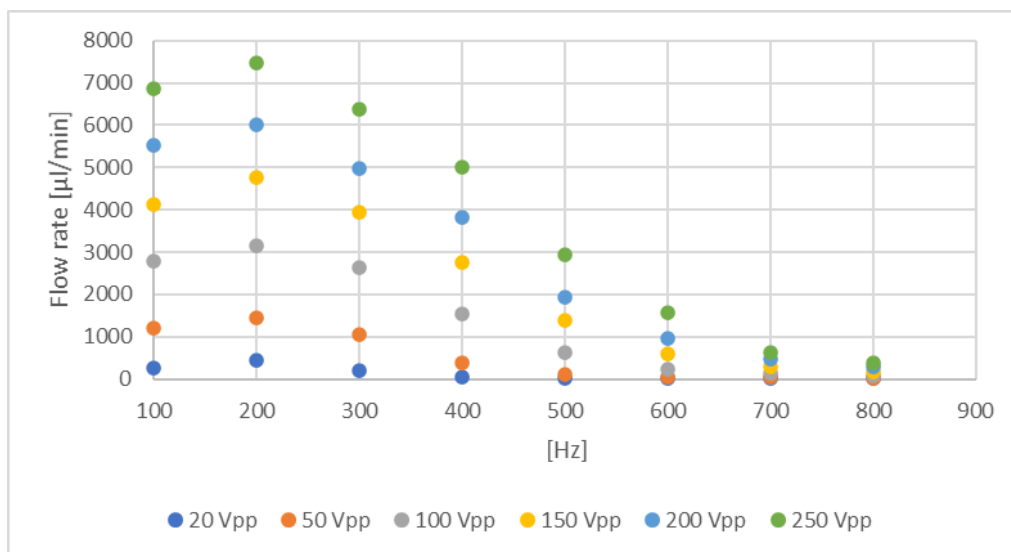

Figure 11 Example mp6 run by mp-Highdriver pumping water (high frequencies)

Option C: Flow restriction

The following figure shows the flow rate behaviour for water of the mp6 run by the mp-Highdriver.

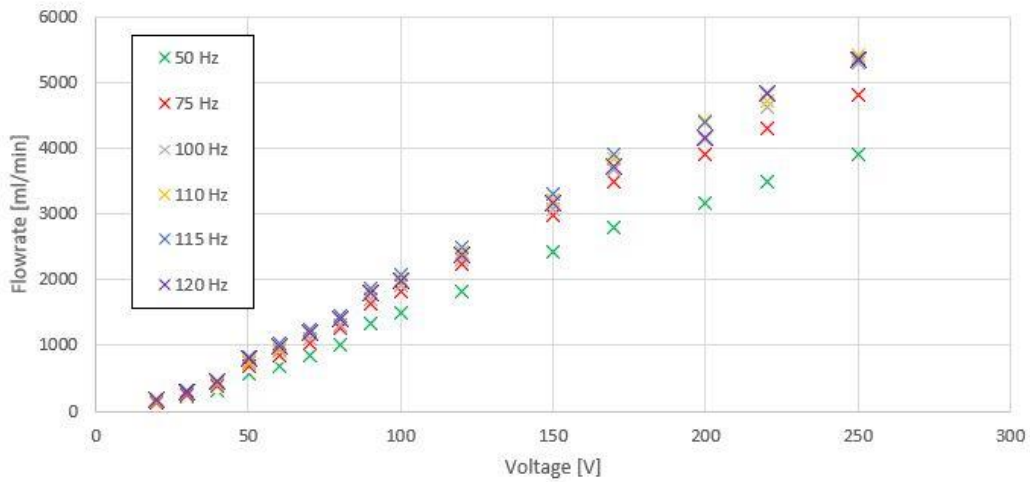

Figure 12 Example mp6 run by mp-Highdriver pumping water (low frequencies)

The mp-Highdriver has got a bottom limit of frequency at 50 Hz. That leads to a bottom flow rate of about **100  $\mu$ l/min**. For decreasing the flow rate even further it is possible to restrict the flow by a capillary for instance. The following figure shows the possible shift of the flow rate utilizing a capillary with a length of 70 mm and an inner diameter of 65  $\mu$ m.

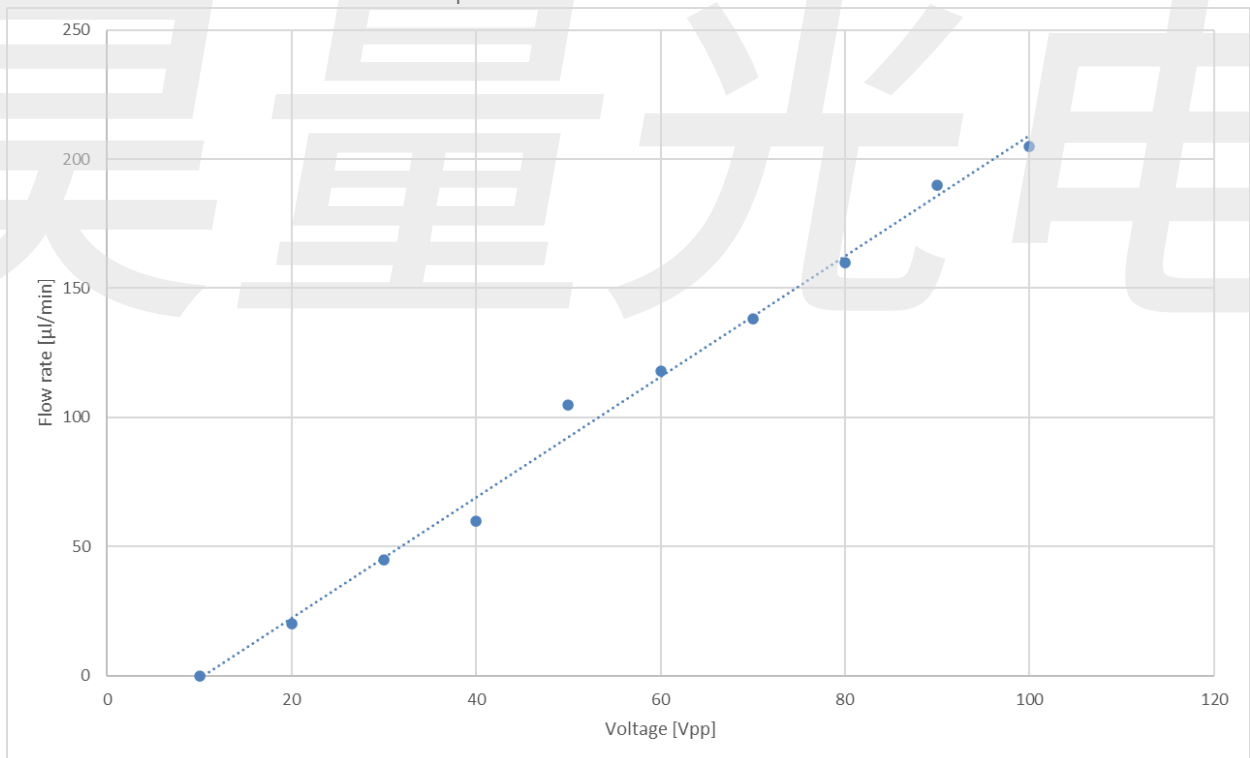

Figure 13 Flow restriction utilizing capillary l = 70 mm and ID = 65  $\mu$ m with mp-Highdriver at 50 Hz pump frequency

## 4 Electronic Specifications mp6 series

### 4.1 Electronic signal

The active components of mp6 micropumps are two build-in piezo actuators. By driving them with an oscillating signal (e.g. sine) the actuators work as pistons to convey fluids. Additionally, they have to be driven with a 180° phase shift to each other. That way, the pulled in fluid inside the first pump chamber can be passed to the second chamber and ejected out of the pump with the next pump cycle. The figure below shows examples of possible driving signal for mp6 micropumps.

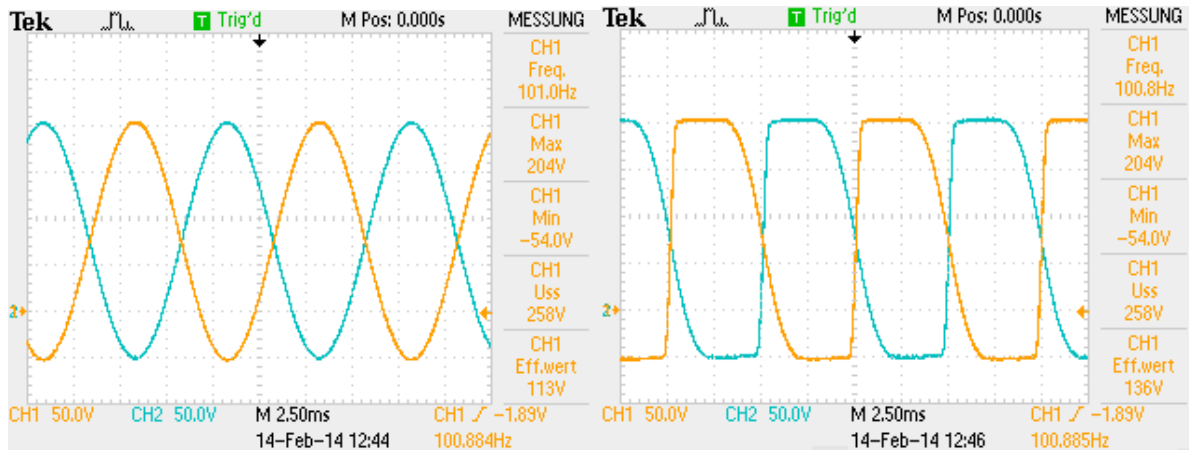

Figure 14 Scopeshots of a mp6 micropump at 250Vpp; 100 Hz; sine signal (left); SRS signal (right) / Voltage at piezo actuator 1  $\triangleq$  CH1 & piezo actuator 2  $\triangleq$  CH2

We recommend a max peak-to-peak voltage of 250Vpp reaching from -50V to +200V. If you apply voltages higher than 270Vpp you risk a surge voltage through the piezo actuator and possibly damage your driving circuit. Furthermore, voltages under -70V can cause a reverse polarisation of the actuators leaving the mp6 micropump unusable. Bartels Mikrotechnik provides four driving options with the following specifications:

Table 5 Overview output/input of all driver types

Driver	Output		Input
	Voltage Range (Vpp)	Frequency (Hz)	Voltage (V DC)
mp-Labtronix	0-250	1-300	12
mp-Specdriver	80-250	1-225	5
mp-Lowdriver	0-150	8-2000	5
mp-Highdriver	0-250	50-800	5
mp-Highdriver4	0-250	50-800	5

### 4.2 Pin-Layout

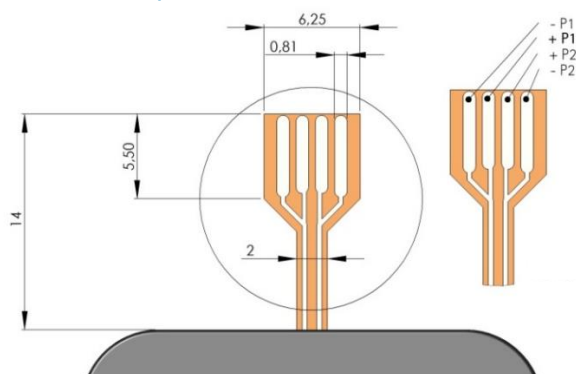

Figure 15 Schematic of the FCC connector of the mp6 micropump; all dimensions in [mm]



The micropumps can be connected via FCC connector. The layout of the connector and pin assignment of the pumps is as shown above. Each piezo (P1 / P2) has a single lead for the negative (P1/-P2) and the positive (+P1/+P2) supply voltage.

The recommended connector is a 4-pin 1.25 mm pitch FCC connector manufactured by Molex. The straight version part number 39 53 2045. An alternative is the angulated version with the part number 39 53 2044.

The recommended maximum wire length between controller and the pump is 1 m. The customer has to assure that the assembly of pump, controller and electrical connection complies with the EMC regulations and electrical safety in the specific field of application.

## 5 Mechanical specifications

### 5.1 Geometry and Handling

The following figures name the most important parts of the pump and the geometric dimensions.

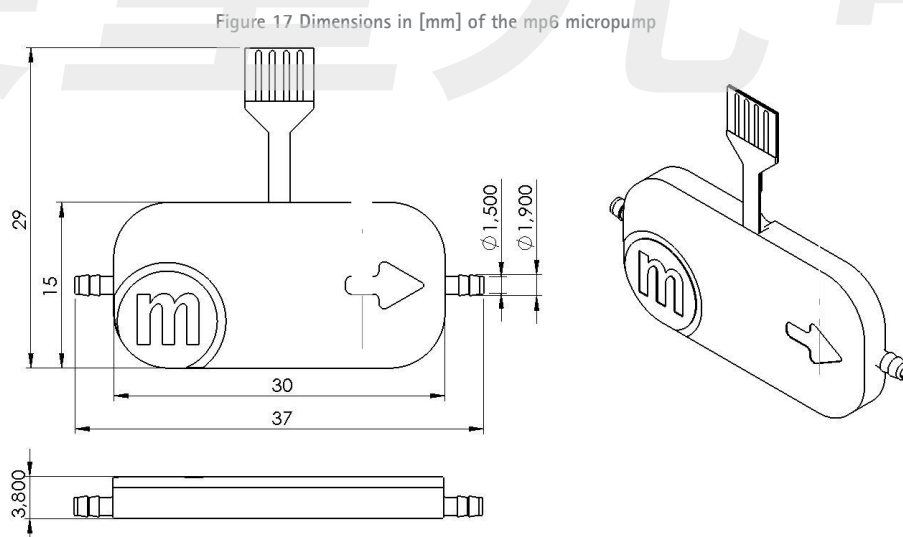
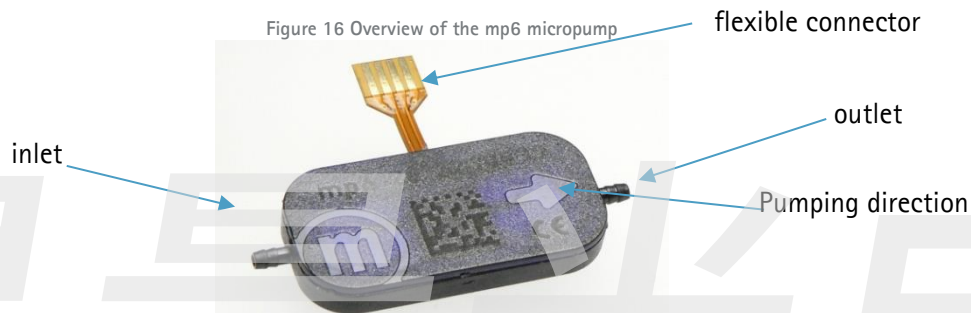

You can find the CAD file in the download section on our website (<https://www.bartels-mikrotechnik.de/en/downloads-english/>)

Please connect suitable tubes to the inlet and outlet. The tubing should have an inner diameter of ~1.3 mm for all mp6 micropumps. The micropump has to be connected to a suitable controller as described in the sections above. Bartels Mikrotechnik recommends the Tygon LMT-55 (for water-based solutions) or F4040 (for solvents) with ID = 1.3 mm and OD = 3 mm.

Data sheet: mp6 series  
Version 2.1 (November 2022)

To connect the pumps and Molex, refer to the following three figures. Orientate both components as indicated on the first picture, the pumps facing downwards with its serial number marking (!) and the Molex connector with the four small openings visible from above. Then insert the mp6 flex into the Molex connector (Step1). Close the Molex connector to complete the interconnection between both components (Step 2).

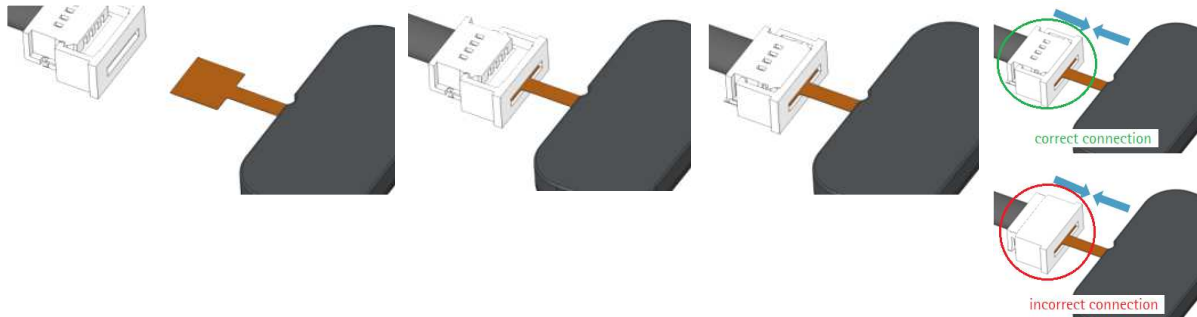

Figure 18 How to connect the mp6 micropump to the Molex connector

When removing the micropump, the Molex connector needs to be opened first!

The Molex flex cable has contacts only on one side, so it can be connected to the Molex connector only in one way. If connected in the other way, the pump will not function.



In order to prevent damage to the flexible cable, the following points should be considered for the final pump assembly:

- the flexible connector must not be bent around sharp edges or kinked
- the flexible connector must not be bend on top or bottom of the pump
- the Molex connector is not watertight, additional sealing with e.g. silicone will be necessary
- fixation of the Molex connector in the final assembly is recommended



Figure 19 Important notes about the proper use of the flexible connector

## 5.2 Internal Volumes

What part	Image	Volume
total		30.2 $\mu$ l
Both pump chambers		13.7 $\mu$ l
both entrances of pump chambers		1.38 $\mu$ l

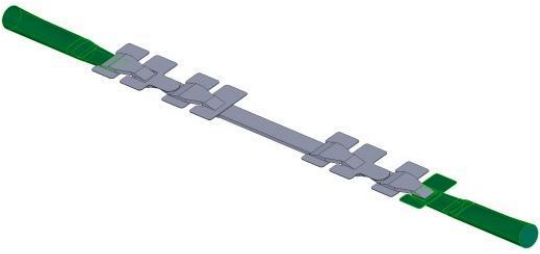
<p><b>channel area</b> - inlet and outlet areas of tubing clips up to internal valve (areas highlighted in green) - rest</p>		<p>- inlet and outlet: 10.32 <math>\mu</math>l - rest: 4.76 <math>\mu</math>l</p>
--	--	---

### 5.3 Mounting

For mechanical mounting of the mp6 micropumps, Bartels Mikrotechnik provides the mp-mf mounting frame. The mp-mf is made from PLA (Polylactide).

See the figures below for the possible mounting option, how to correctly insert the mp6 micropump into the frame. M1.6 mm screws are suitable with this frame.



Figure 20 Pictures of the mounting frame mp-mf

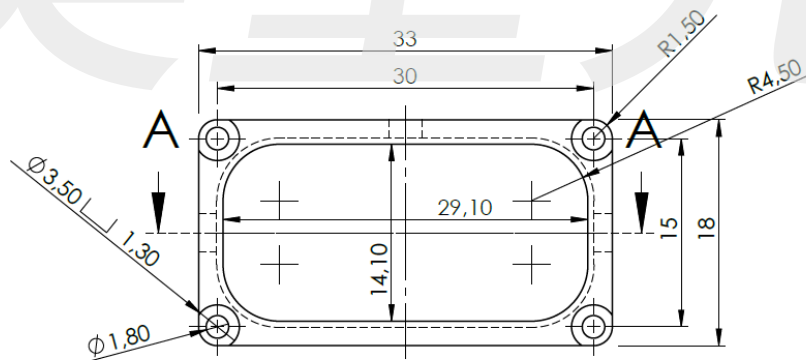

Figure 21 Dimensions of the mounting frame mp-mf

You can find the CAD file in the download section on our website (<https://www.bartels-mikrotechnik.de/en/downloads-english/>)

## 6 Ordering Information and Packaging mp6 series

The MOQ of pumps is ten and the pumps are shipped bags. One packaging unit contains ten pumps.

Product	Description	Order code
mp6-liq	Pump optimized for liquids	mp6-liq
mp6-gas	Pump optimized for gases	mp6-gas
mp6-gas+	Pump optimized for gases	mp6-gas+

mp-basic set	Basic evaluation kit (see below)	mp-basic set
mp-advance set	Extensive evaluation kit (see below)	mp-advance set
mp-Lab! set	Laboratory evaluation kit (see below)	mp-Lab! set

Our evaluation kits come with everything necessary to start testing, including pump, electronics and PC application for configuration and control. The evaluation kits are suitable for laboratory testing, proof of concept and product prototyping. Contact us to request a quotation or visit our online shop to see the current portfolio of our evaluation kits (<https://bartels-mikrotechnik.shop/>).

## 7 Important Notices

This operating manual contains necessary instructions for the installation, commissioning, operation and maintenance of the mp6-series. The manual is intended to help you achieving optimal results in a short time and shall also assist avoiding possible sources of errors. The operating manual of the controllers and the accessories are available separately.

The products have been designed with state-of-the-art technology and in accordance with all relevant safety regulations. However, a risk of damage to the units, other property, the operator and/or other persons cannot be fully excluded.

Always ensure that specialized and trained personnel will comply with the following general instructions. Therefore, please keep this manual and hand out copies as required.

All values are approximate and no guarantee of specific technical properties.  
Changes in the course of technical progress are possible without notice.

### 7.1 Warranty

The mp6 micropumps have been developed for the transport of gases or liquids. The controllers have been developed for operating the mp6 micropumps. Bartels Mikrotechnik can assume no liability for damages resulting from the pump media. This applies especially for hazardous fluids.

The mp6 micropumps must be operated with Bartels Mikrotechnik electronics. Bartels Mikrotechnik GmbH cannot guarantee the proper work of the units with customer specific electronics. If other controllers than the ones from Bartels Mikrotechnik are used, Bartels Mikrotechnik disclaims any warranty.

Bartels Mikrotechnik assumes no liability for abnormal handling, improper or negligent use of the mp6 micropumps and the controller that is not conform to the specified purpose of the system. This applies especially for micropump controllers, components and systems of other manufacturers, which have not been certified by Bartels Mikrotechnik.

We guarantee that the mp6 micropumps comply with the actual state of scientific and technical knowledge and due to this, the operational risks are limited to a minimum.

Bartels Mikrotechnik GmbH warrants solely to the original purchaser of this product for a period of 12 months (one year) from the date of delivery that this product shall be of the quality, material and workmanship defined in Bartels Mikrotechnik GmbH published specifications of the product. Within such period, if proven to be defective, Bartels Mikrotechnik GmbH shall repair and/or replace this product, in Bartels Mikrotechnik GmbH's discretion, free of charge to the Buyer, provided that:

- notice in writing describing the defects shall be given to Bartels Mikrotechnik GmbH within fourteen (14) days after their appearance

- such defects shall be found, to Bartels Mikrotechnik GmbH's reasonable satisfaction, to have arisen from Bartels Mikrotechnik GmbH's faulty design, material or workmanship
- the defective product shall be returned to Bartels Mikrotechnik's factory at the Buyer's expense
- the warranty period for any repaired or replaced product shall be limited to the unexpired portion of the original period.

This warranty does not apply to any equipment which has not been installed and used within the specifications recommended by Bartels Mikrotechnik GmbH for the intended and proper use of the equipment.

EXCEPT FOR THE WARRANTIES EXPRESSLY SET FORTH HEREIN, Bartels Mikrotechnik GmbH MAKES NO WARRANTIES, EITHER EXPRESS OR IMPLIED, WITH RESPECT TO THE PRODUCT. ANY AND ALL WARRANTIES, INCLUDING WITHOUT LIMITATION, WARRANTIES OF MERCHANTABILITY OR FITNESS FOR A PARTICULAR PURPOSE, ARE EXPRESSLY EXCLUDED AND DECLINED. Bartels Mikrotechnik GmbH is only liable for defects of this product arising under the conditions of operation provided for in the data sheet and proper use of the goods. Bartels Mikrotechnik GmbH explicitly disclaims all warranties, express or implied, for any period during which the goods are operated or stored not in accordance with the technical specifications. Bartels Mikrotechnik GmbH does not assume any liability arising out of any application or use of any product or circuit and specifically disclaims any and all liability, including without limitation consequential or incidental damages. All operating parameters, including without limitation recommended parameters, must be validated for each customer's applications by customer's technical experts. Recommended parameters can and do vary in different applications. Bartels Mikrotechnik GmbH reserves the right, without further notice, (i) to change the product specifications and/or the information in this document and (ii) to improve reliability, functions and design of this product.

## 7.2 Warning, Personal Injury

Bartels Mikrotechnik GmbH rejects any responsibility for damages to persons or property resulting from non-compliance with the instructions in this manual. In this case all warranties shall be void.

Do not use this product as safety or emergency stop devices or in any other application where failure of the product could result in personal injury. Do not use this product for applications other than its intended and authorized use. Before installing, handling, using or servicing this product, please consult the data sheet and application notes. Failure to comply with these instructions could result in death or serious injury. If the Buyer shall purchase or use Bartels Mikrotechnik GmbH products for any unintended or unauthorized application, Buyer shall defend, indemnify and hold harmless Bartels Mikrotechnik GmbH and its officers, employees, subsidiaries, affiliates and distributors against all claims, costs, damages and expenses, and reasonable attorney fees arising out of, directly or indirectly, any claim of personal injury or death associated with such unintended or unauthorized use, even if Bartels Mikrotechnik GmbH shall be allegedly negligent with respect to the design or the manufacture of the product.

**Moreover, please note that components of the controller and pump are operating with high voltage. Therefore, persons wearing pacemakers are recommended to avoid the operating system. Do not open the housing of the micropump and the controllers.**

The use of liquids, which may alone or in combination create explosive or otherwise health-endangering conditions (including vapors) is not permitted.

All work in connection with the installation, assembly, commissioning/decommissioning, disassembly, operation, servicing, cleaning and repairing of the pump and the controller must be carried out by qualified, suitably trained and instructed personnel. Work on electrical components and assemblies must be carried out by personnel with the necessary qualifications and skills.

We guarantee that the micropumps comply with the actual state of scientific and technical knowledge and due to this, the operational risks are limited to a minimum.

ESD Precautions: The inherent design of the active electronic components, i.e. mp-Lowdriver, -Highdriver, -Highdriver4, Valvedriver and -Labtronix causes it to be sensitive to electrostatic discharge (ESD). To prevent ESD-induced damage and/or degradation, take customary and statutory ESD precautions when handling this product.

### 7.3 Declaration of conformity

Bartels Mikrotechnik GmbH declares that the products are compliant to the RoHS directive 2011/65/EU. The controllers comply with the requirements of EMV 2014/30/EU and CE markings have been affixed to the devices. Additionally, the controllers are also compliant to the EU Low Voltage Directive 2014/35/EU.

## 8 Company information



Bartels Mikrotechnik is a globally active manufacturer and development service provider in the field of microfluidics. In the microEngineering division, the company supports industrial customers in the modification, adaptation and new development of high-performance and market-oriented product solutions through the innovative means of microsystems technology. The second division, microComponents, produces and distributes microfluidic products and systems, especially for miniaturized and portable applications. Our key products are micropumps that convey smallest quantities of gases or liquids and are used in a variety of ways in biotechnology, pharmaceuticals, medical technology and numerous other applications.

Bartels Mikrotechnik with passion for microfluidics!